

Платье
__G46_
Нижняя
Верх 2

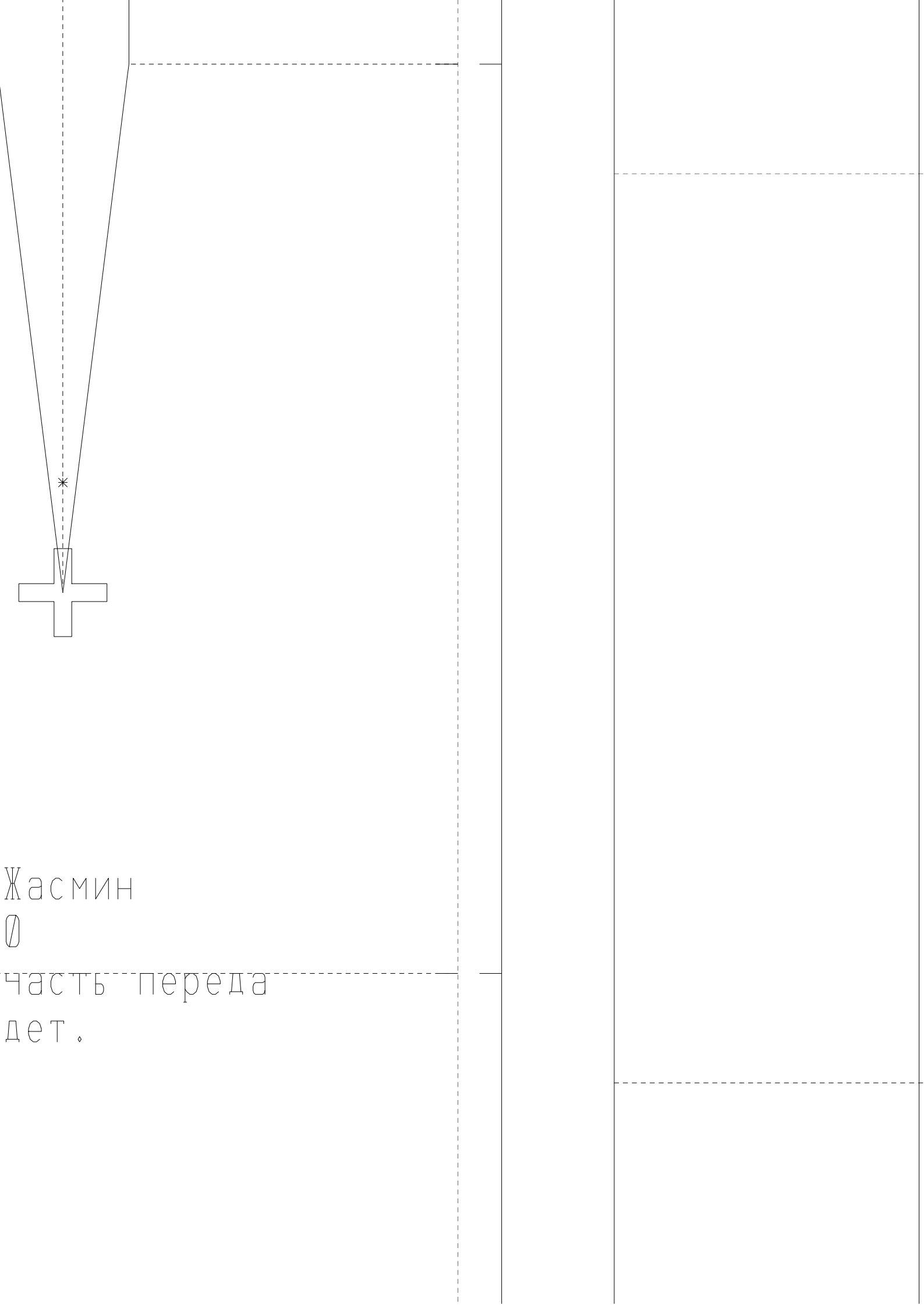

Жасмин
0

часть переда
дет.

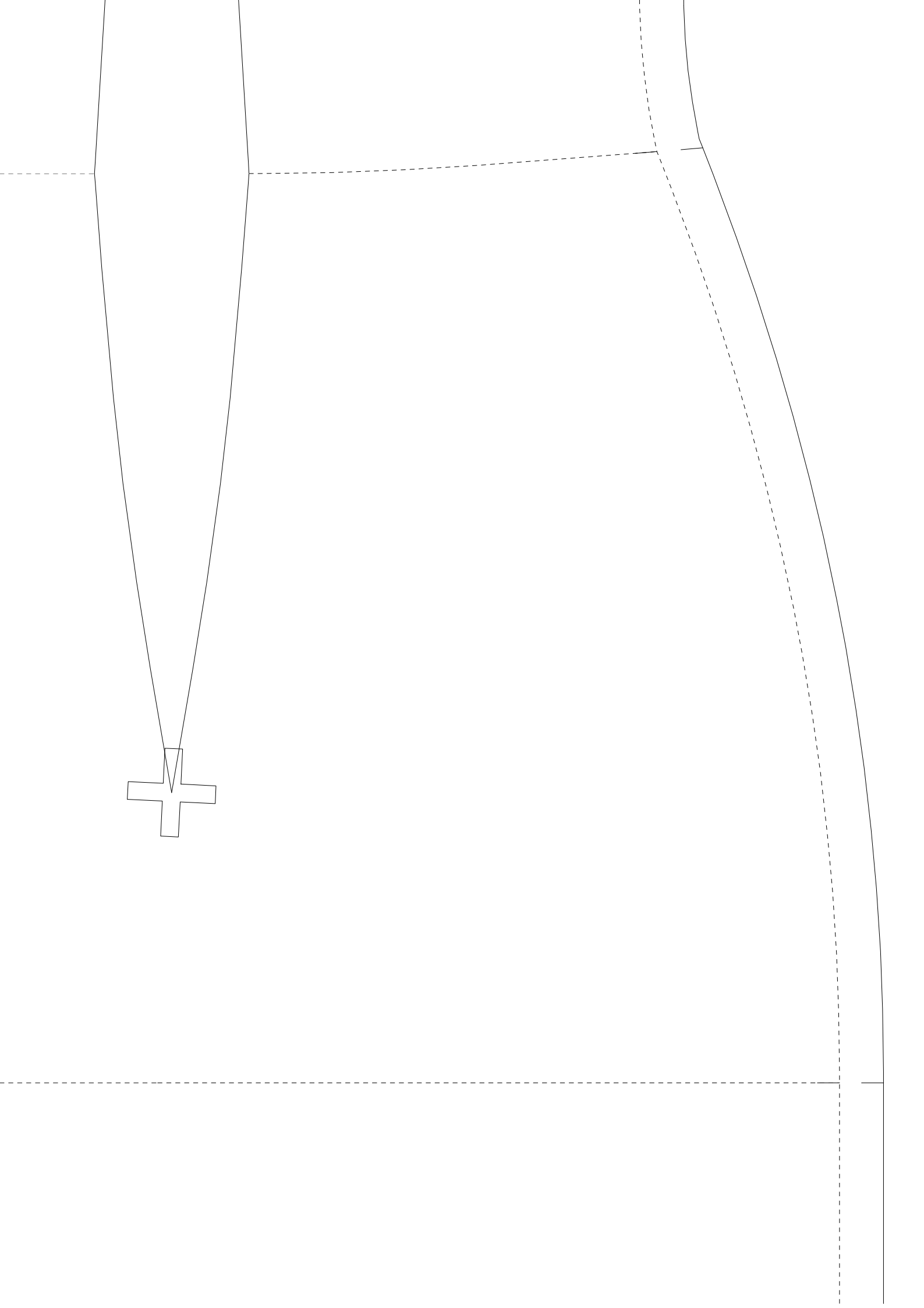

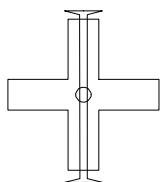
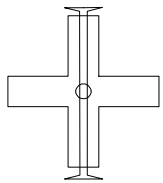
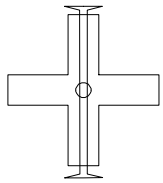
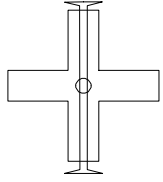
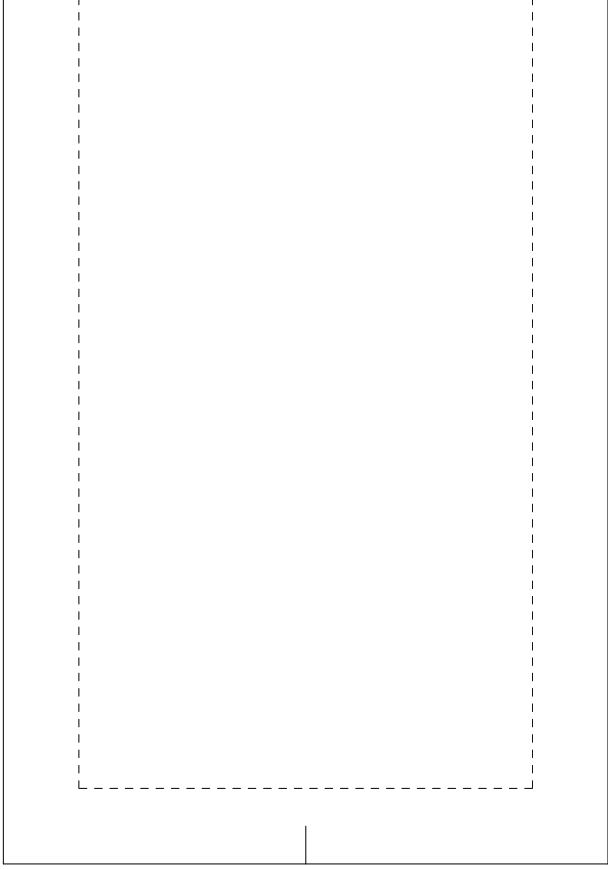

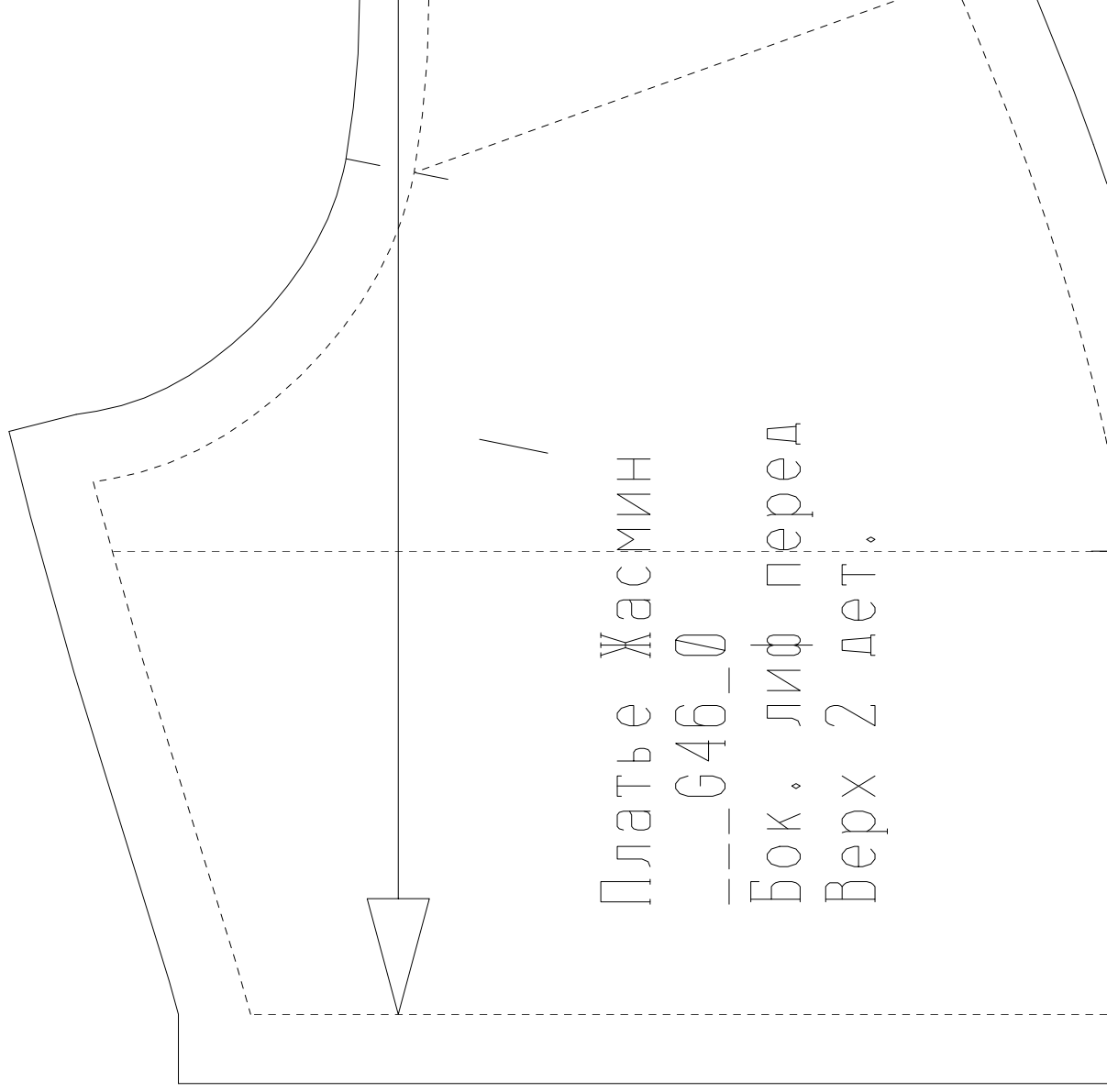

Платье Жасмин

--- G46_0

Бок. лиф перед

Верх 2 дет.

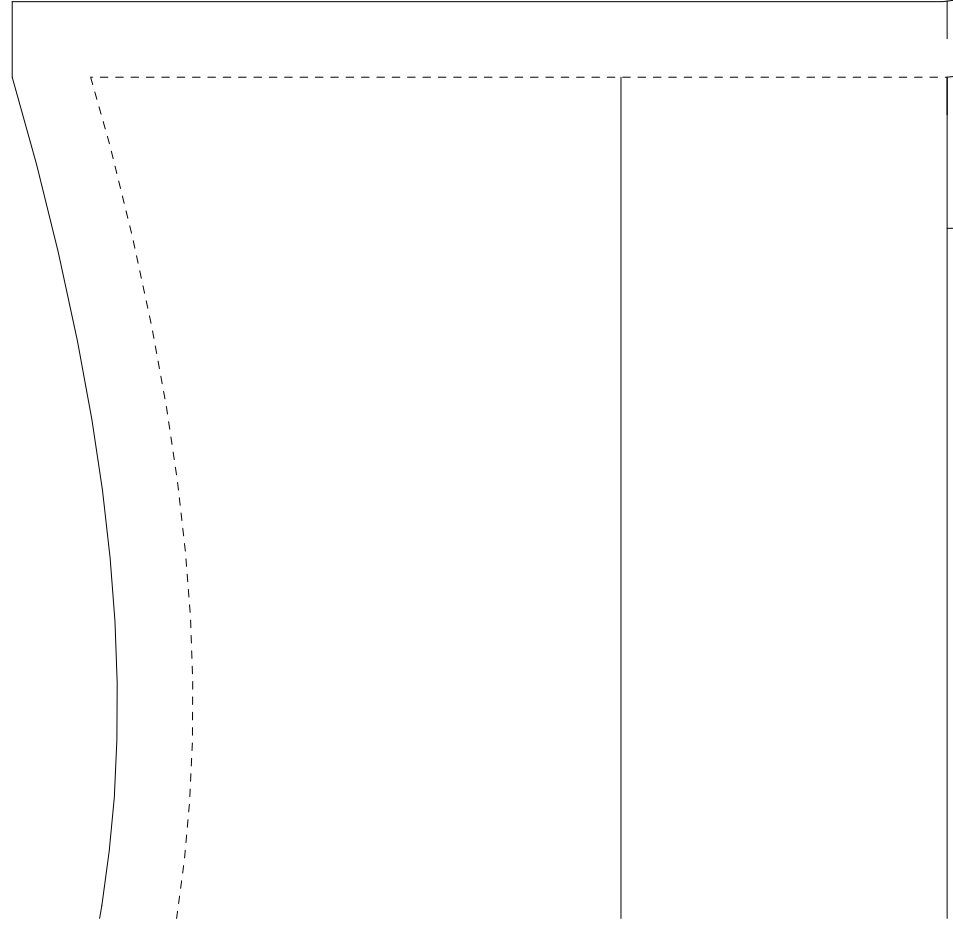

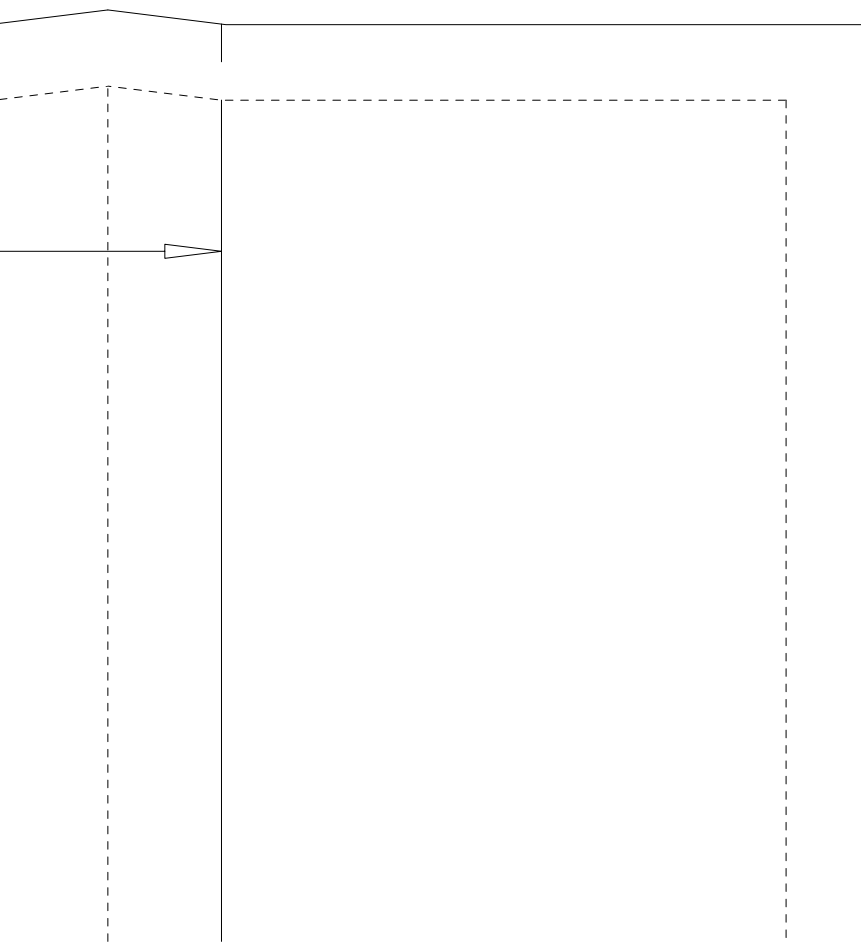
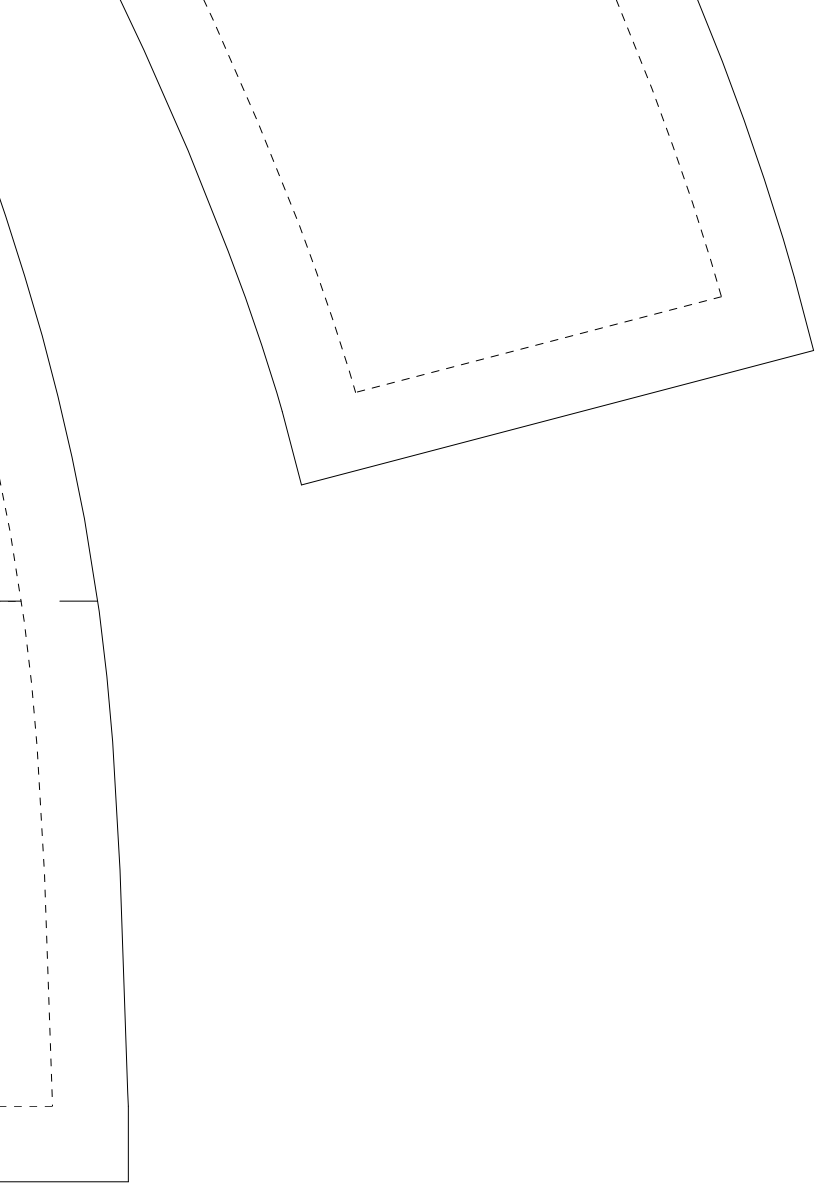

Платье У
___G46___
Спинка
Верх 1 д

Касмин

дет.

Квадрат 10 10

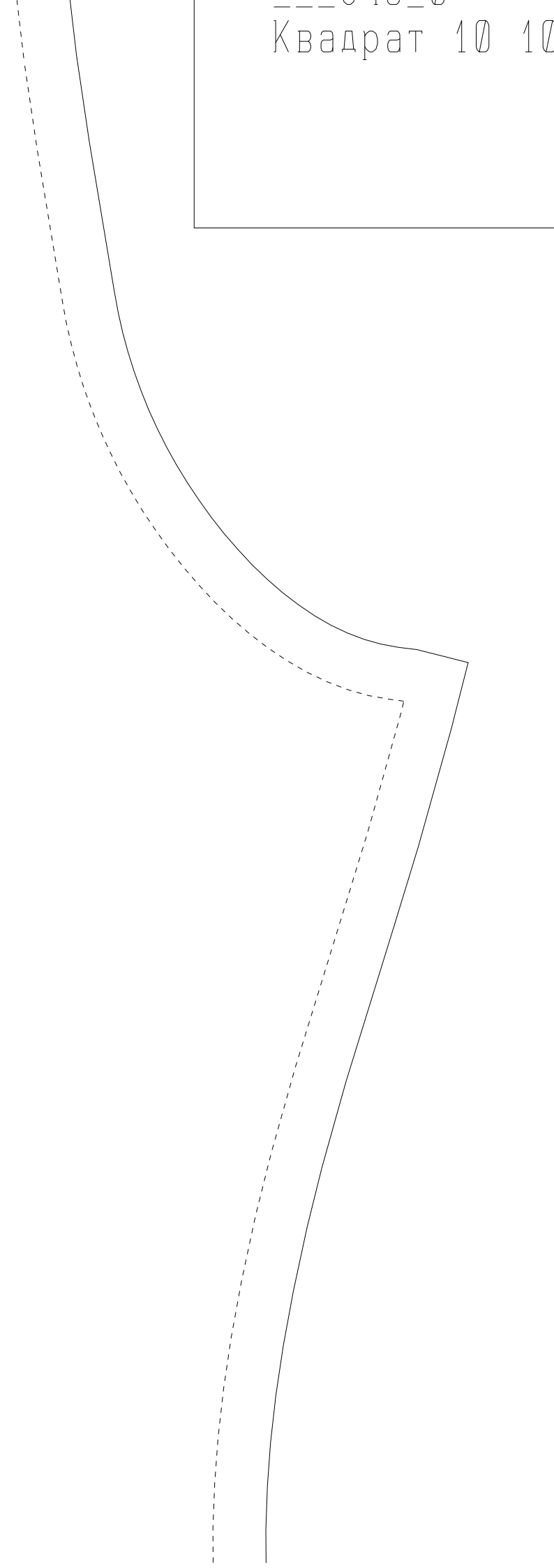
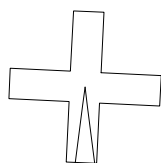

Платье Жасмин

__G46_0

манжет

Верх 2 дет.



Платье Жасмин

__G46_0

Планка

Верх 2 дет.

Клей 2 дет.

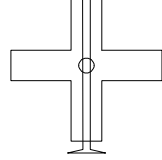
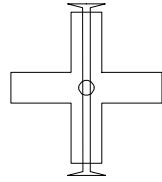
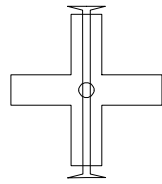
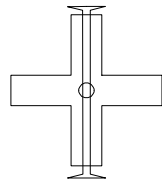
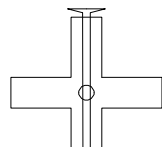

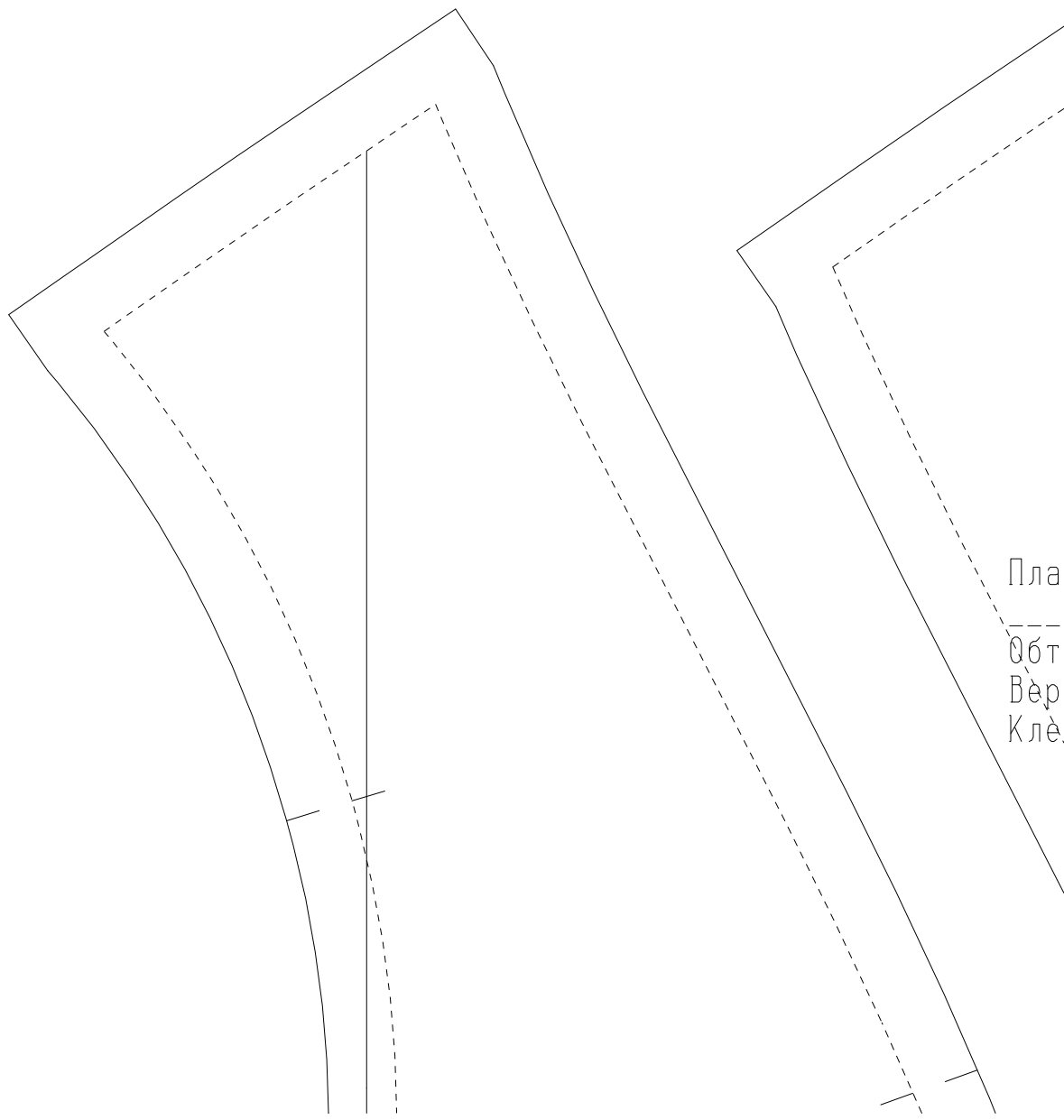
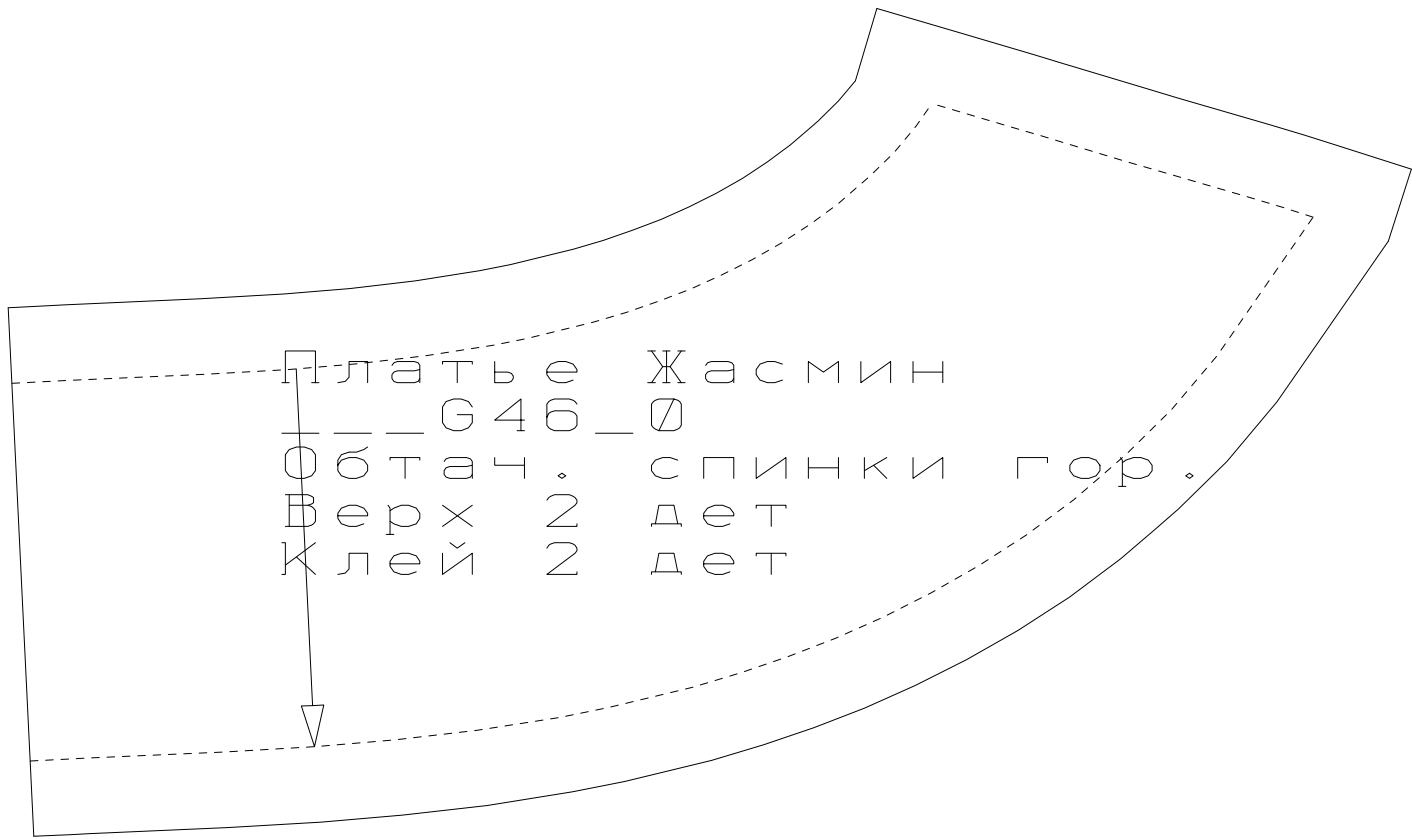

тье Жасмин
G46_0
ачка бок. переда
х 2 дет.
й 2 дет.

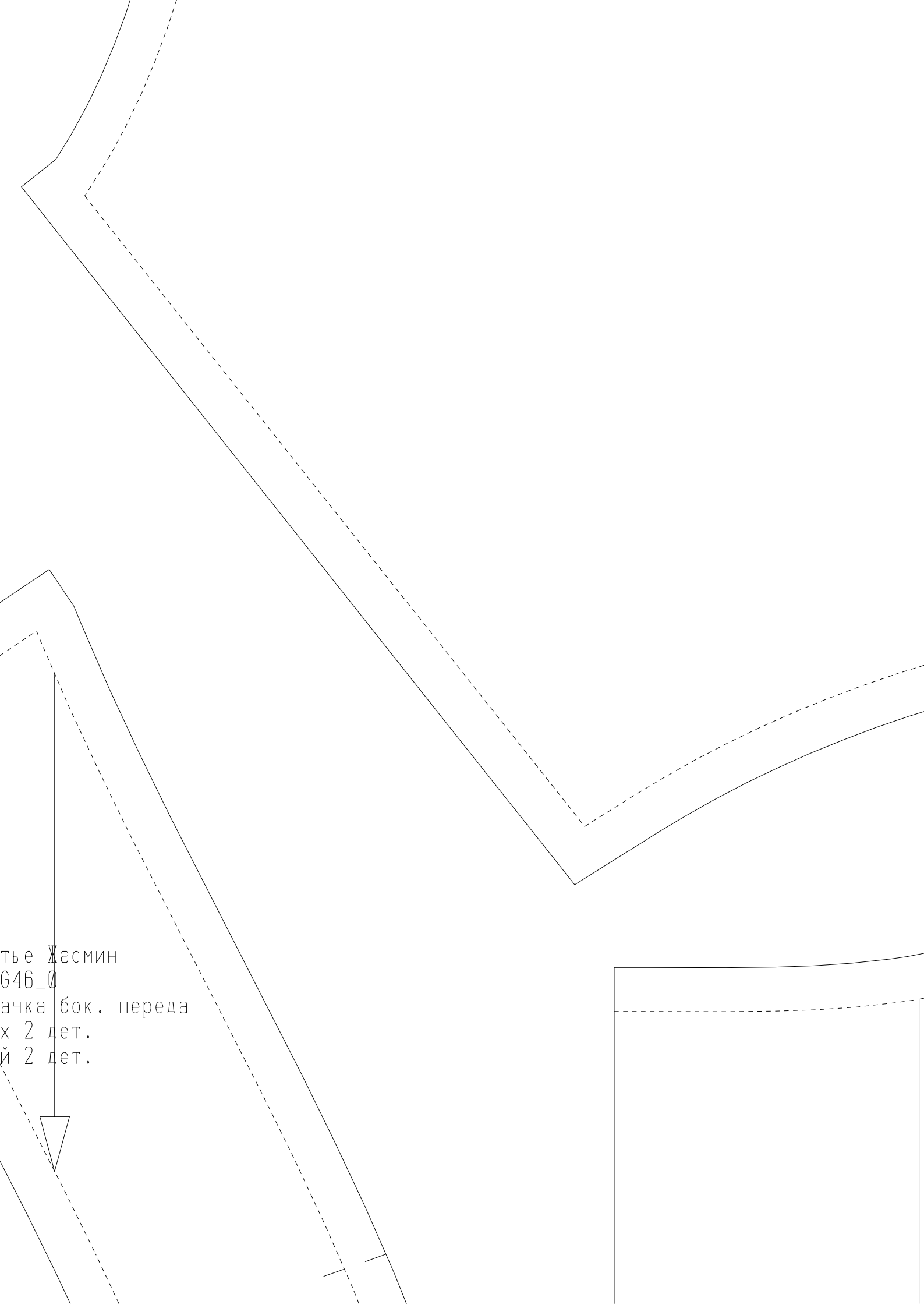

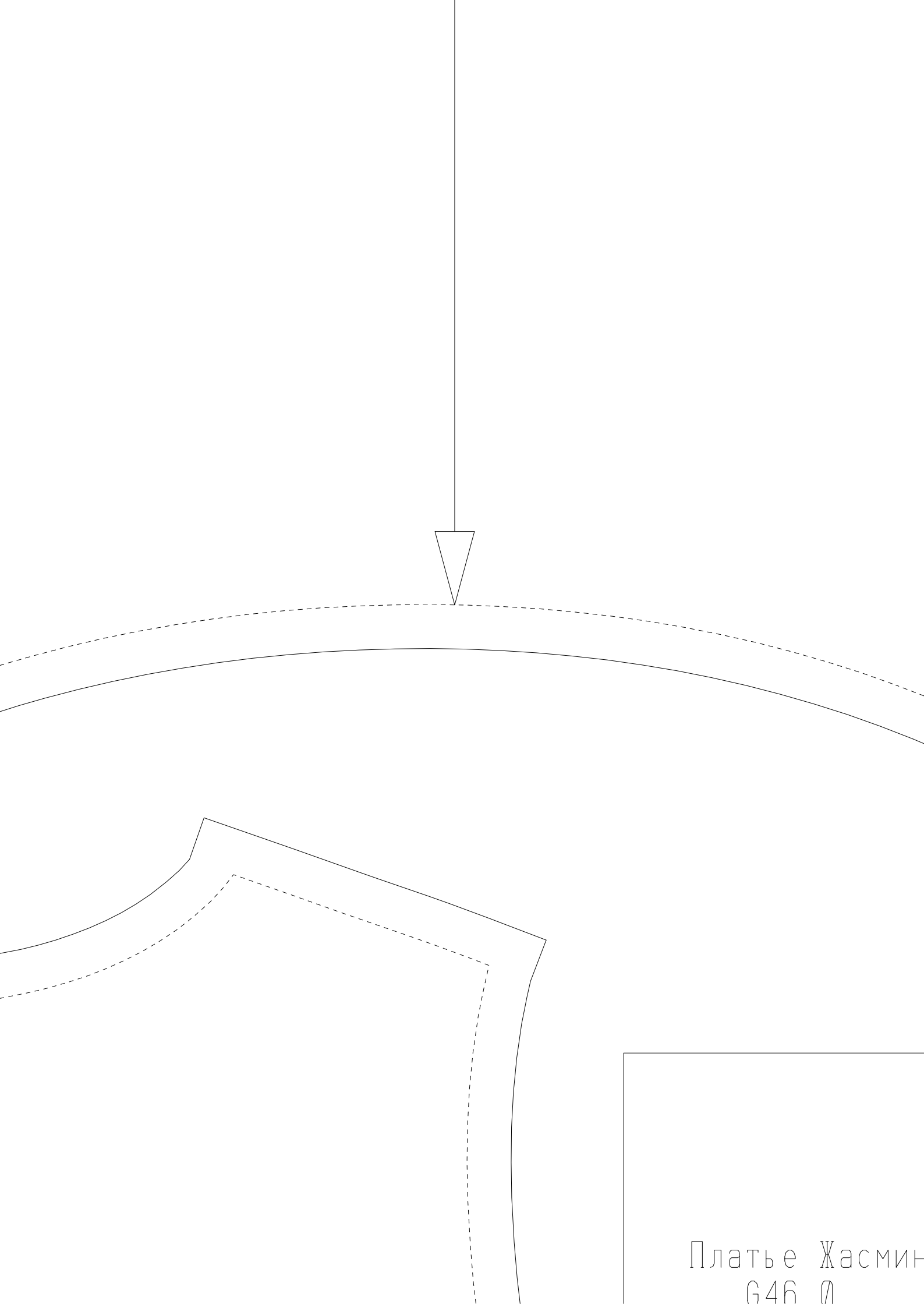

Платье Жасмин
646 0

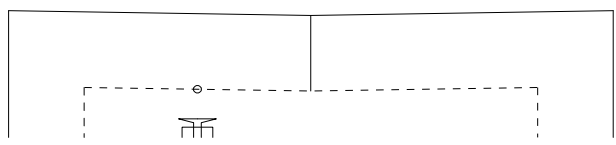
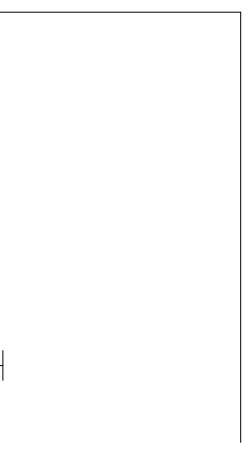
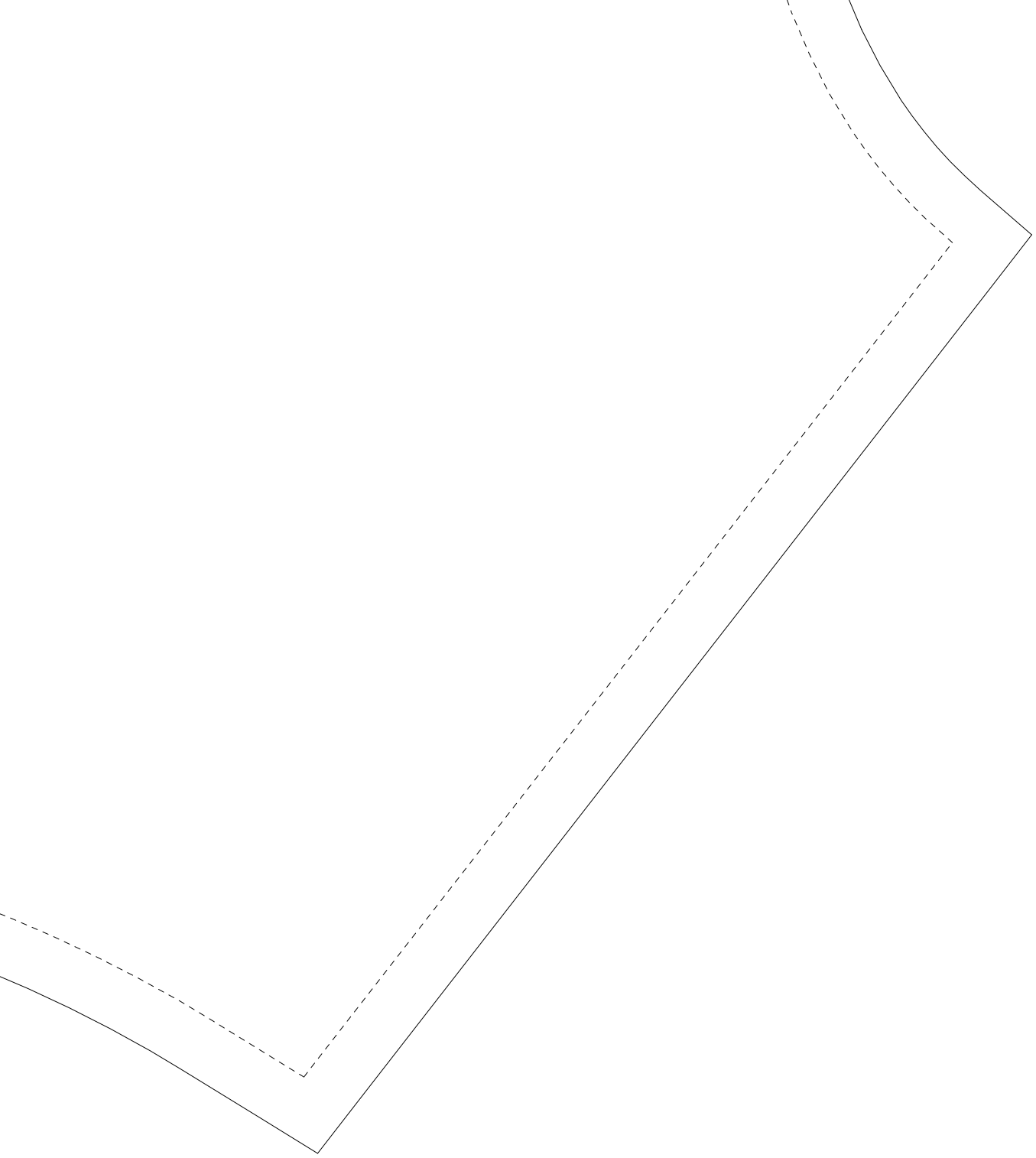



Платье Жасмин

___G46_0

Центр. лиф переда

Верх 2 дет.



Платье Жасмин

___G46_0

Обтачка цент. пер.

Верх 2 дет.

Клей 2 дет.



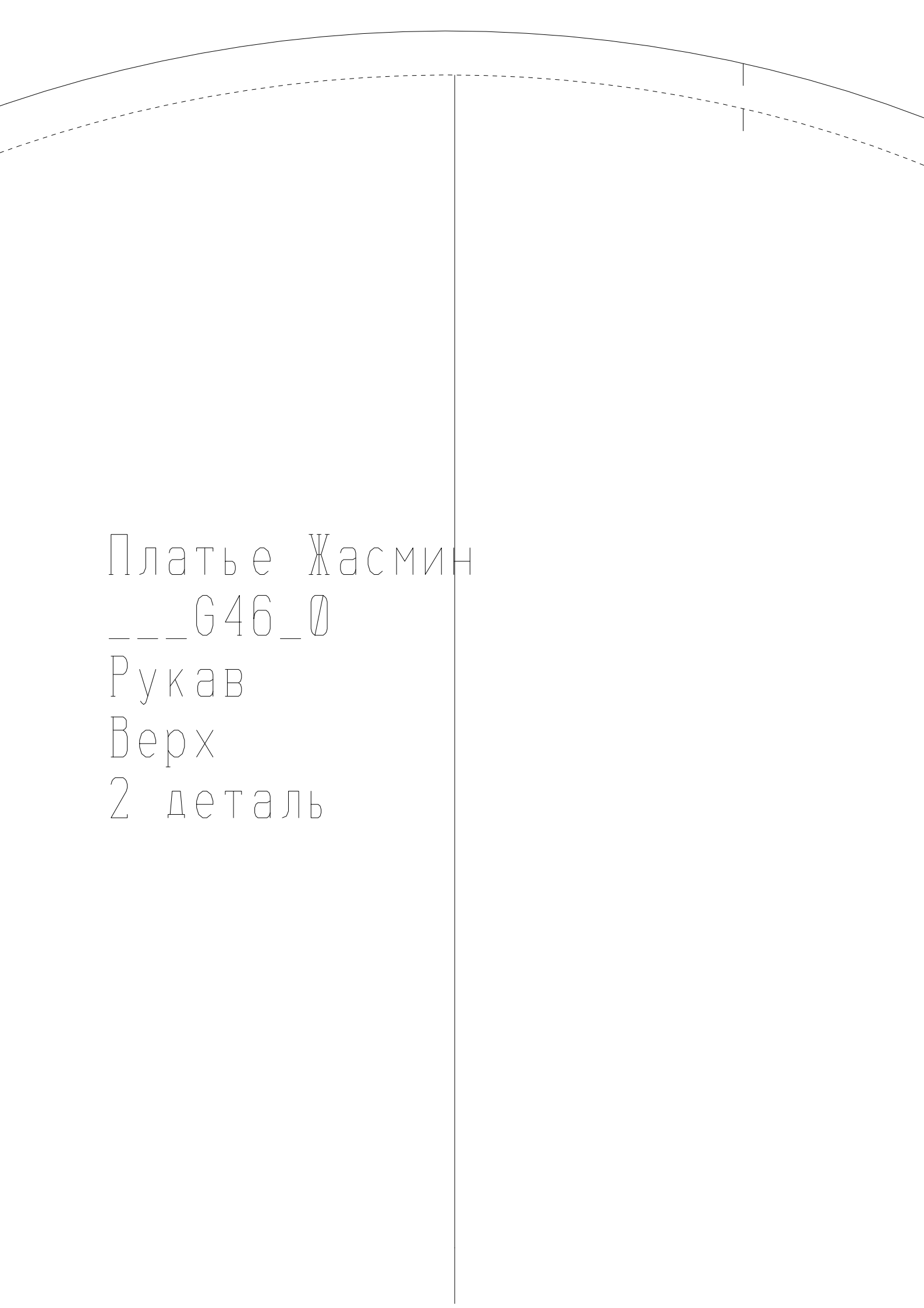

Платье Жасмин

The image shows a technical drawing of a sleeve pattern piece. It features a curved top edge, a dashed line representing the inner curve, and a vertical line extending downwards from the center of the top curve. There are two small vertical tick marks on the right side of the top curve, one on the solid line and one on the dashed line.

___G46_0

Рукав

Верх

2 деталь

