

Плат

Нижн
Верх

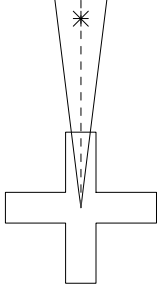

ть е Жасмин

644_0

няя часть переда

к 2 дет.

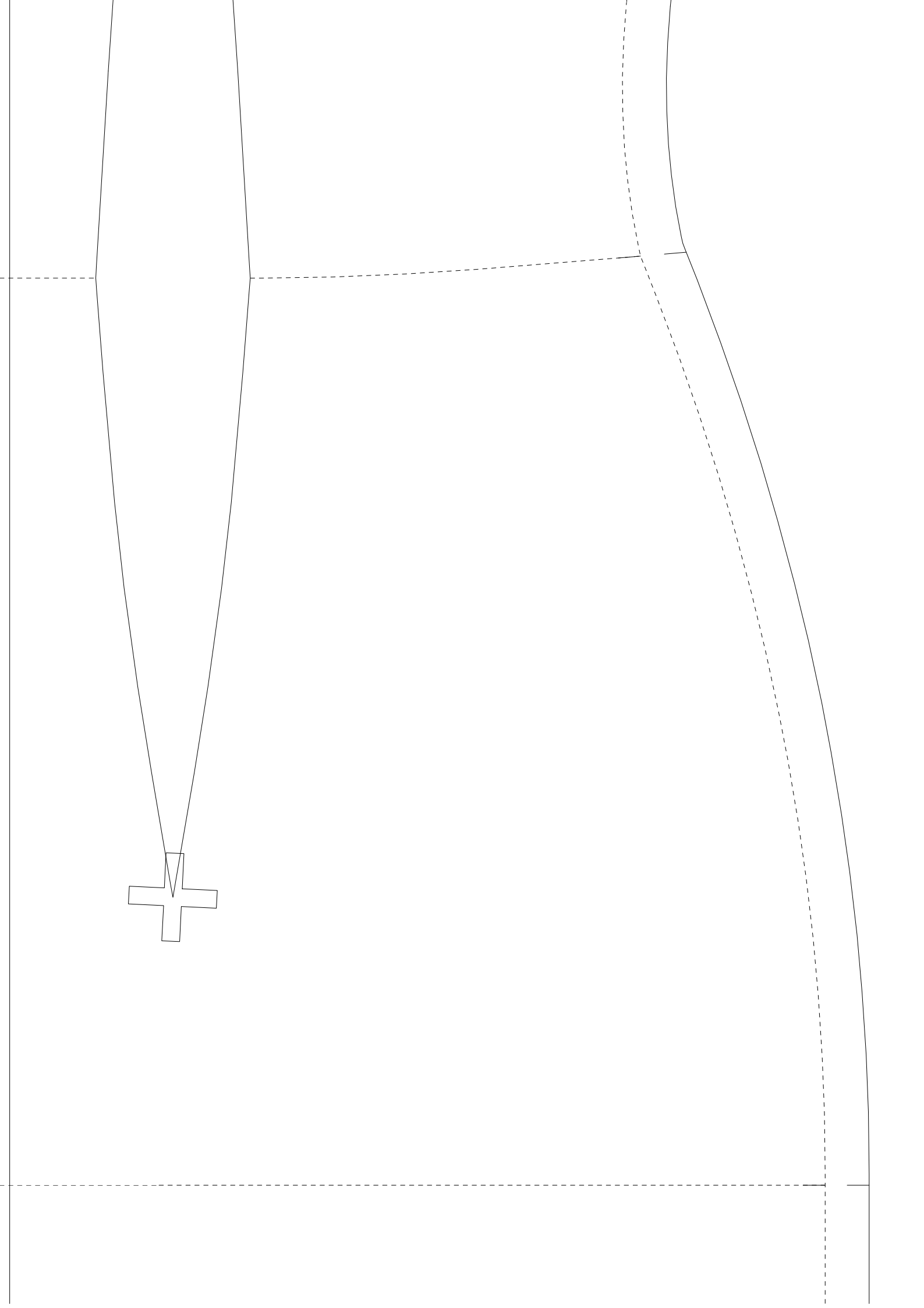

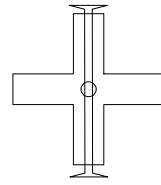
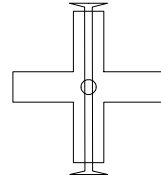
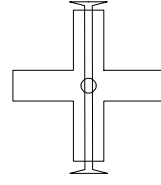
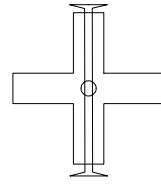
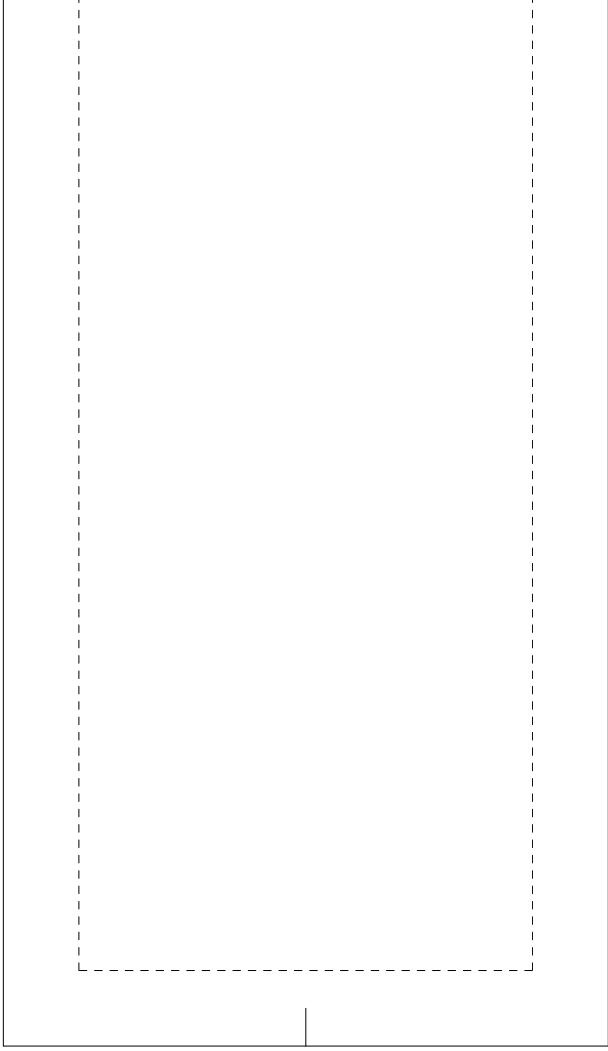

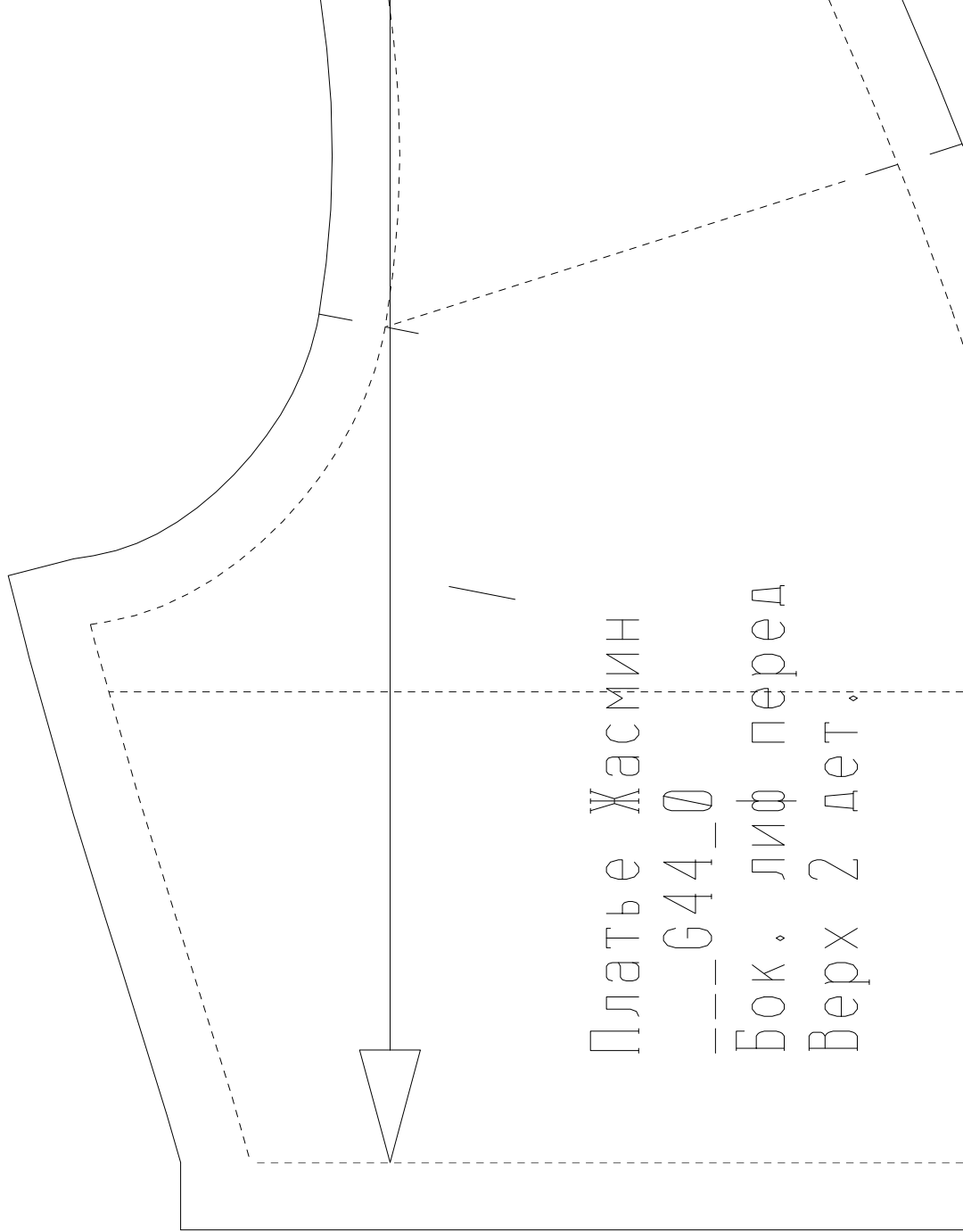

Платье Жасмин
---G44_0
Бок. лиф перед
Верх 2 дет.

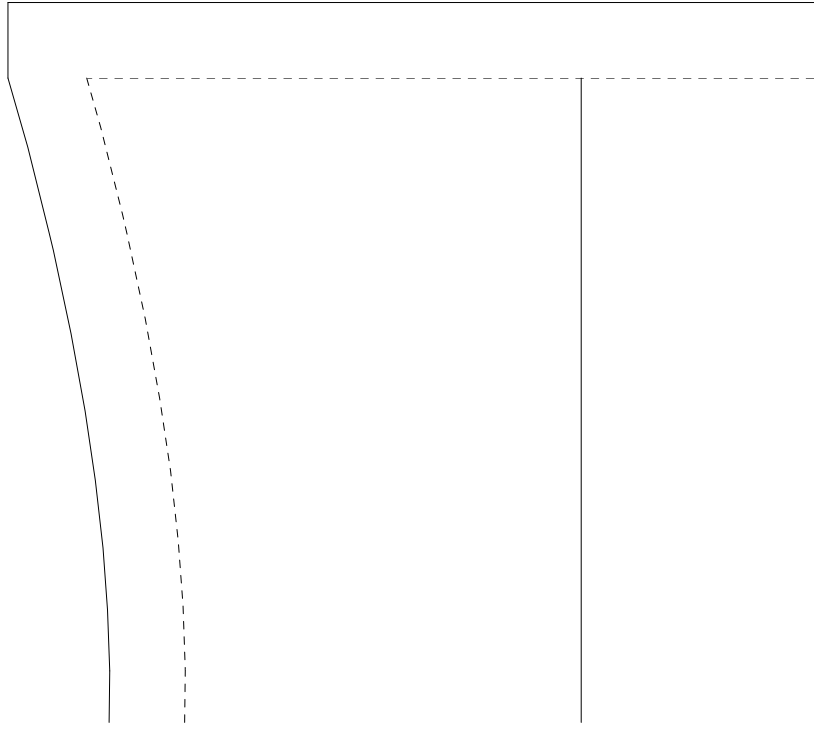

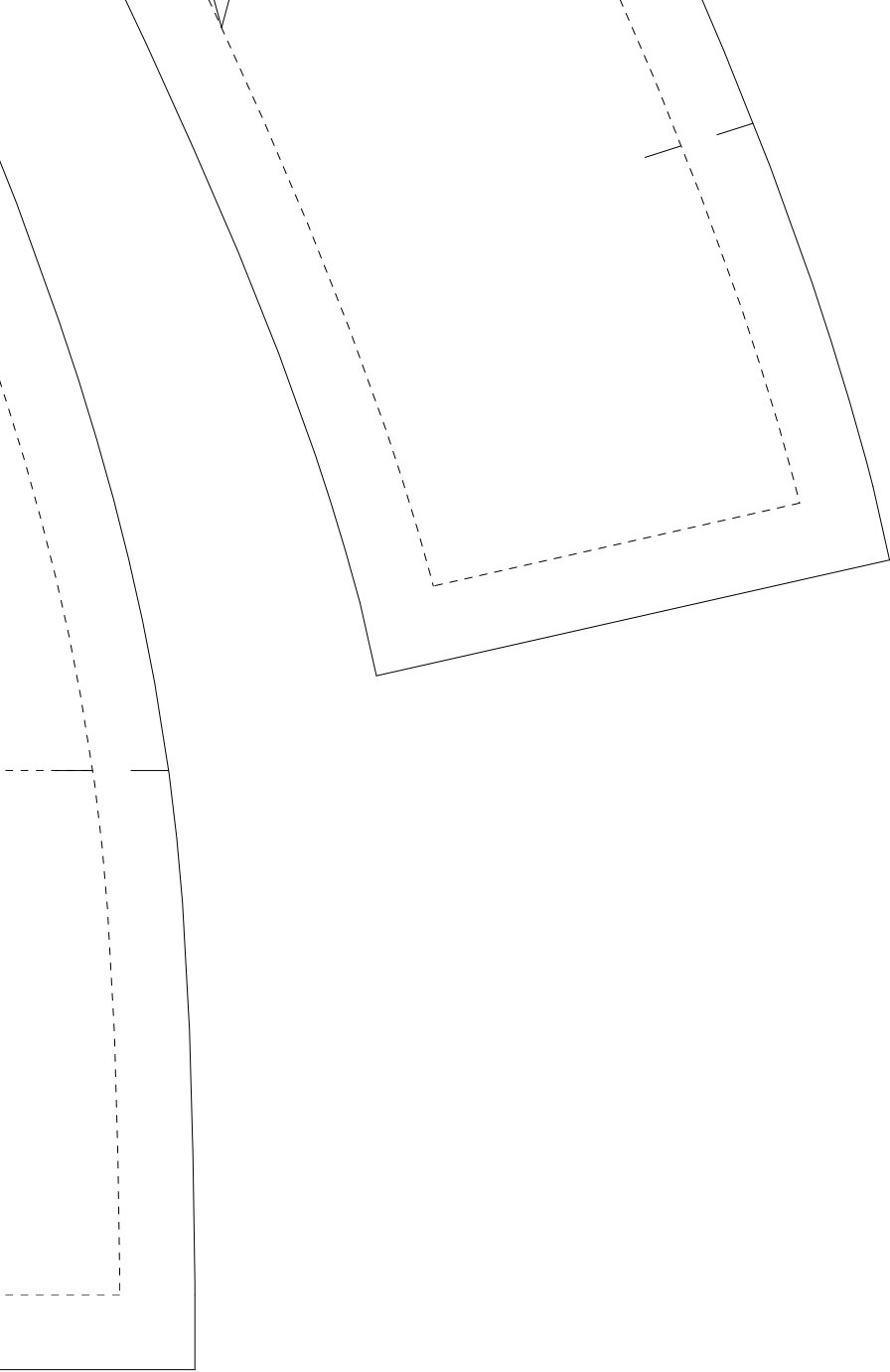

Платье
___G44___
Спинка
Верх 1

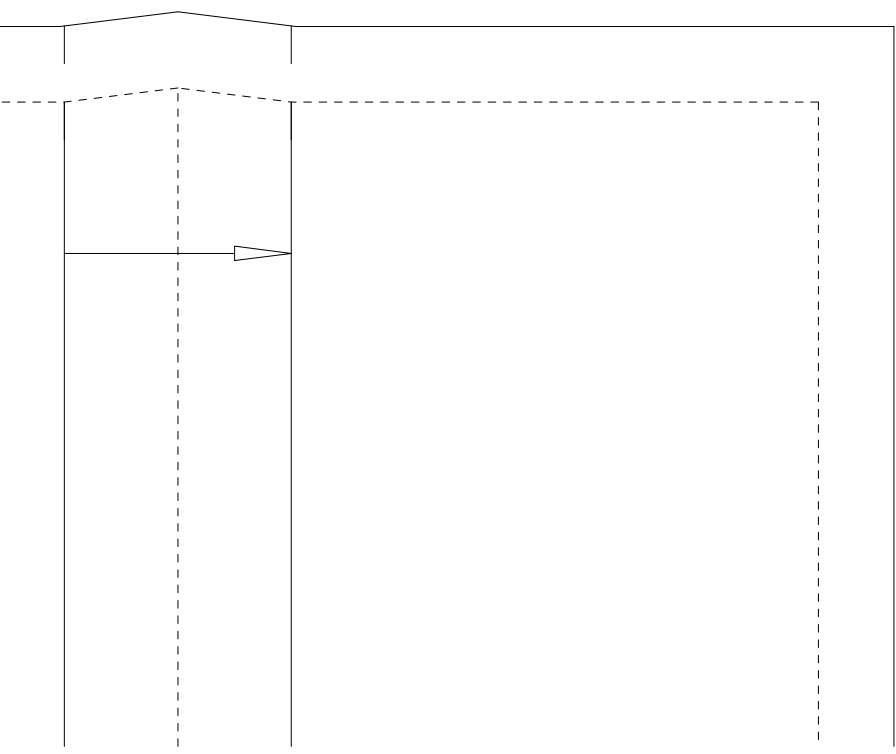

Платье Жасмин
___G44_0
Квадрат 10 1

Жасмин

0

дет.

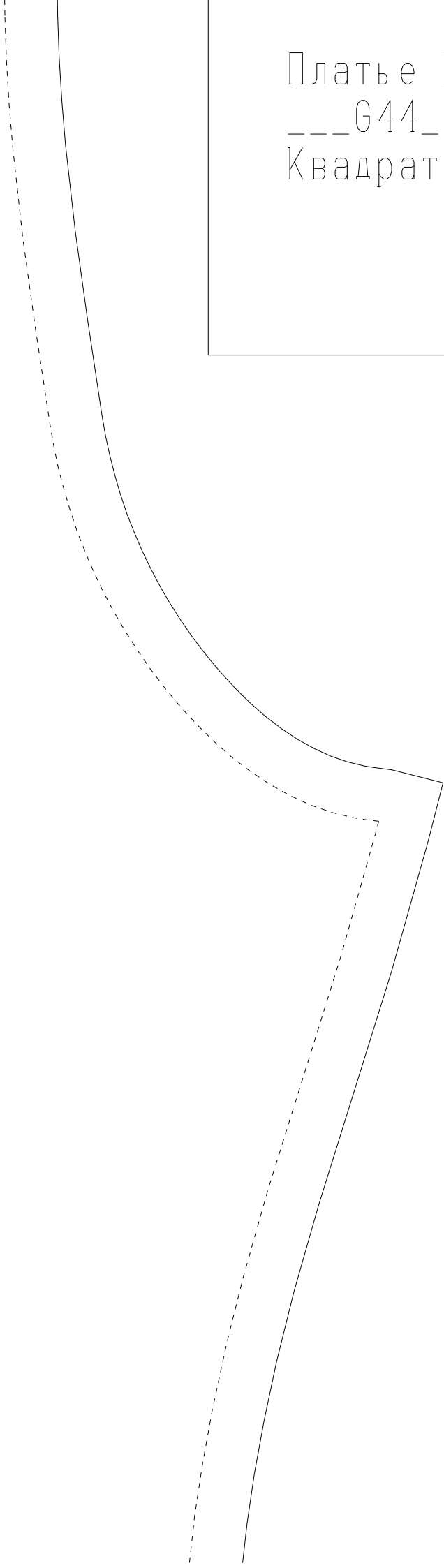
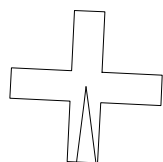

1H
0

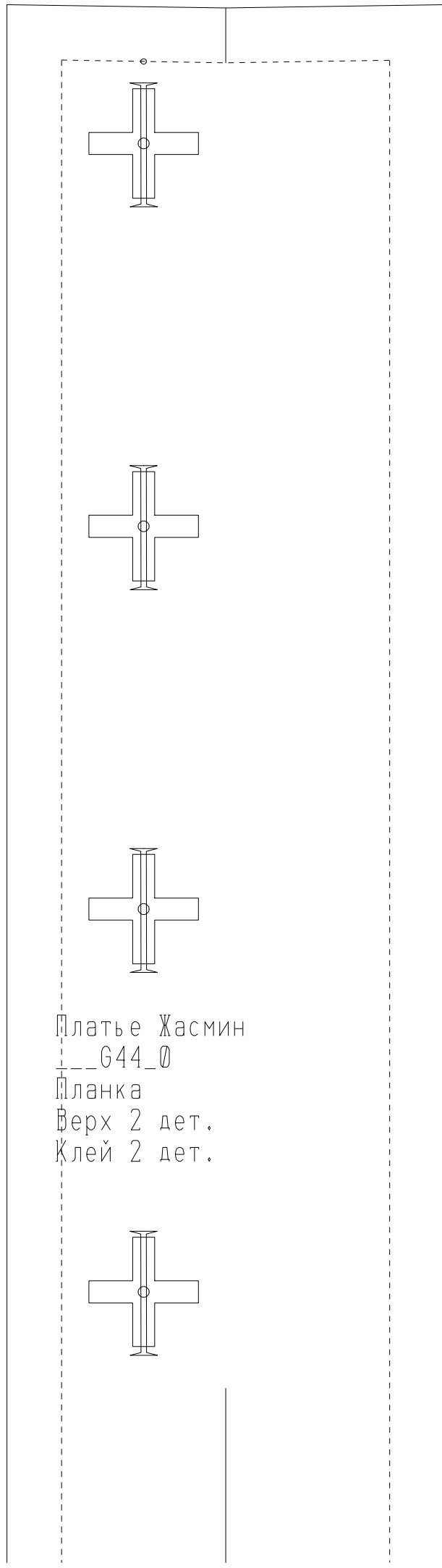
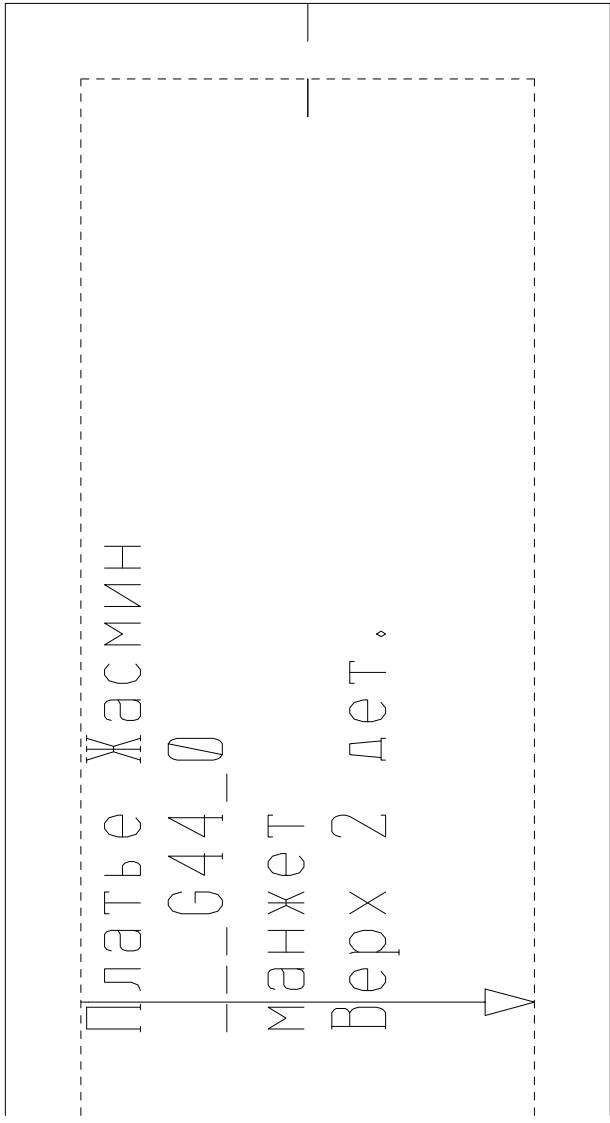

Клей 2 дет. ▾

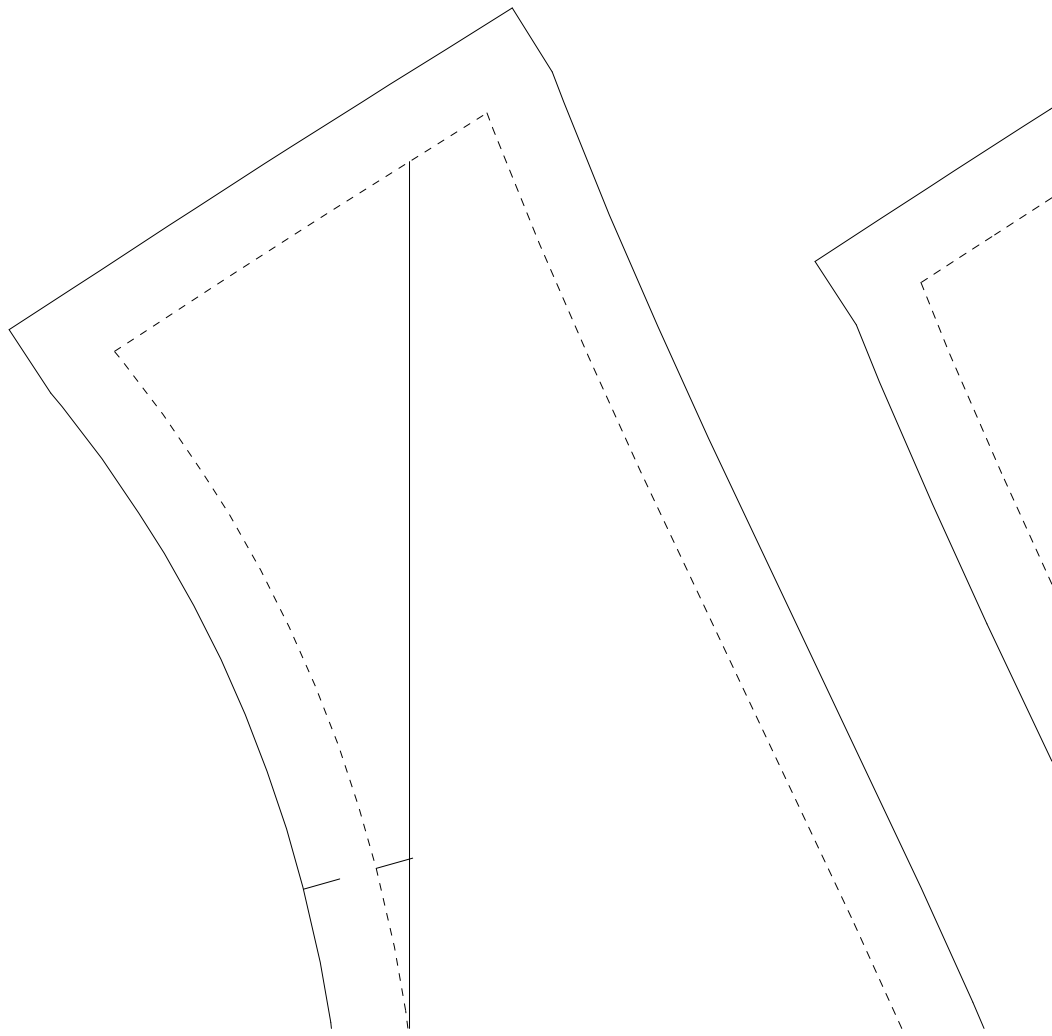
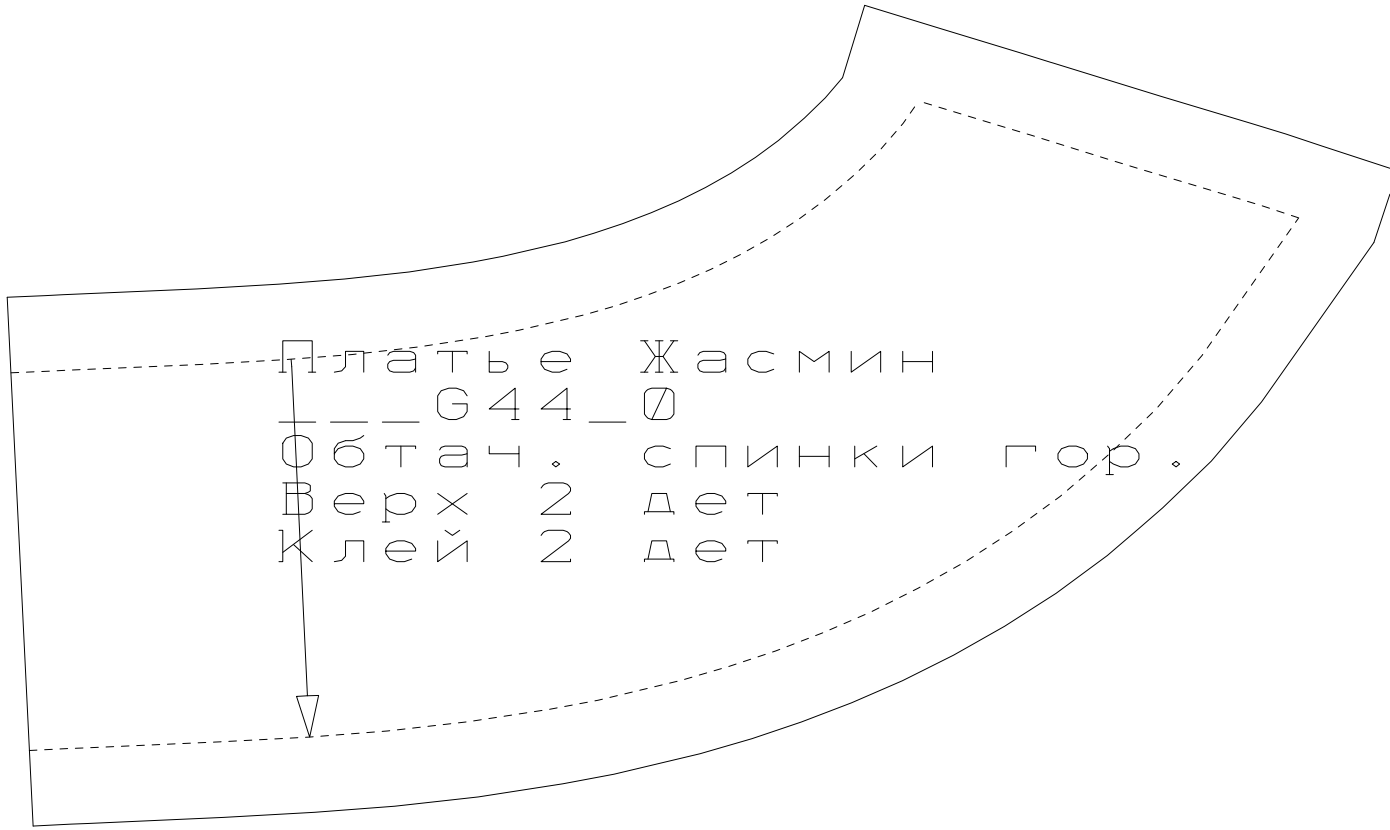

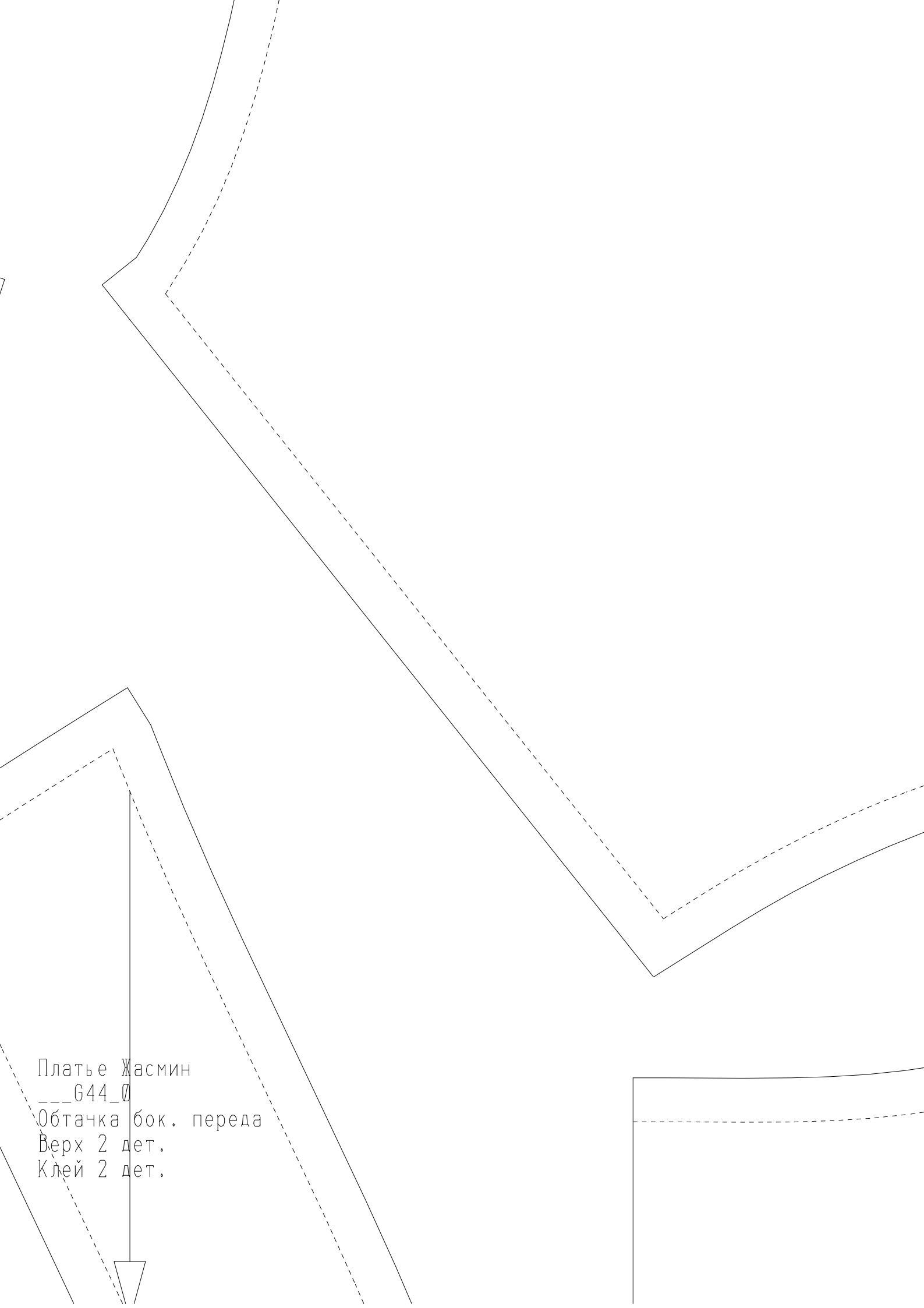

Платье Жасмин
___G44_0
Обтачка бок. переда
Верх 2 дет.
Клей 2 дет.



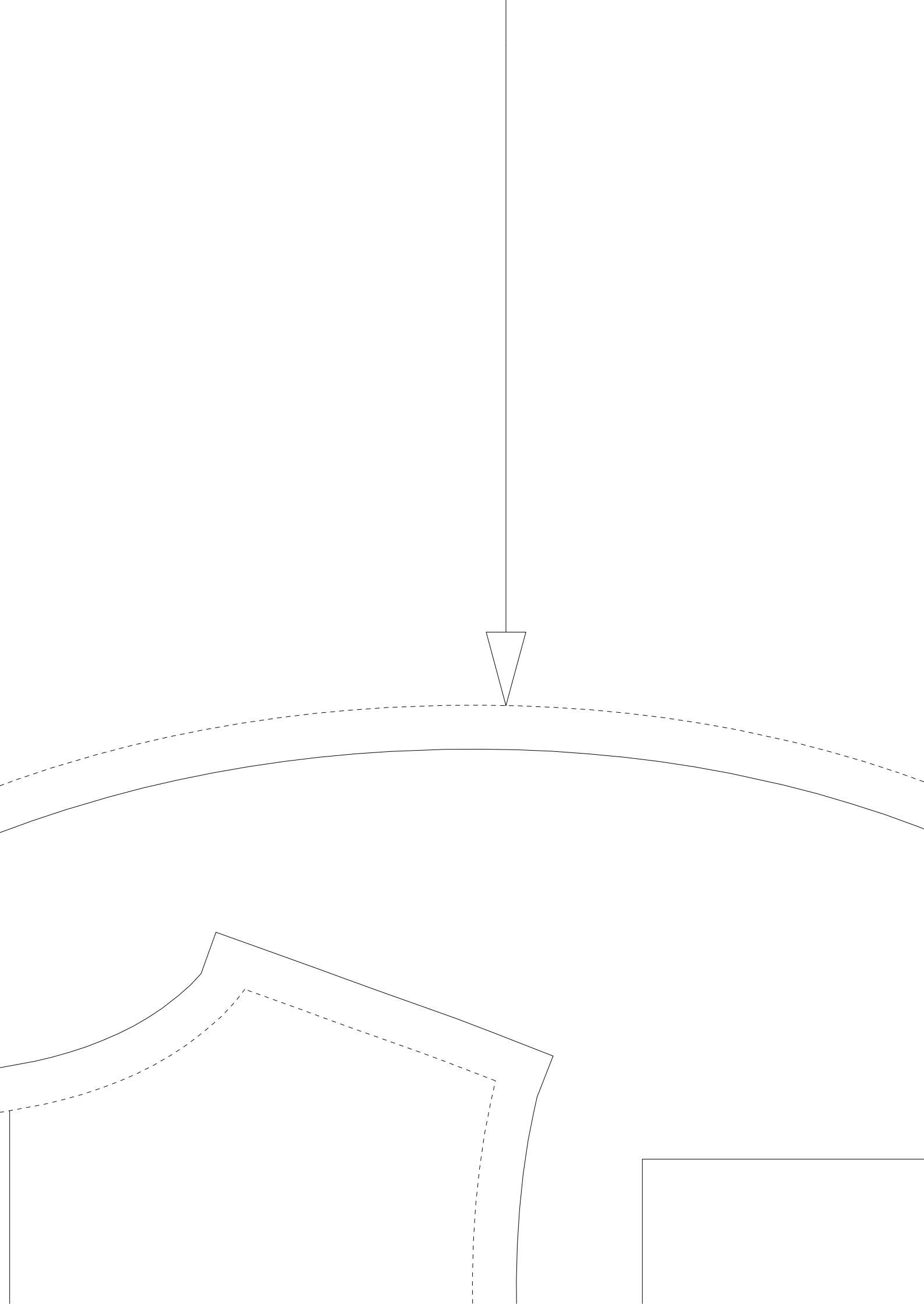

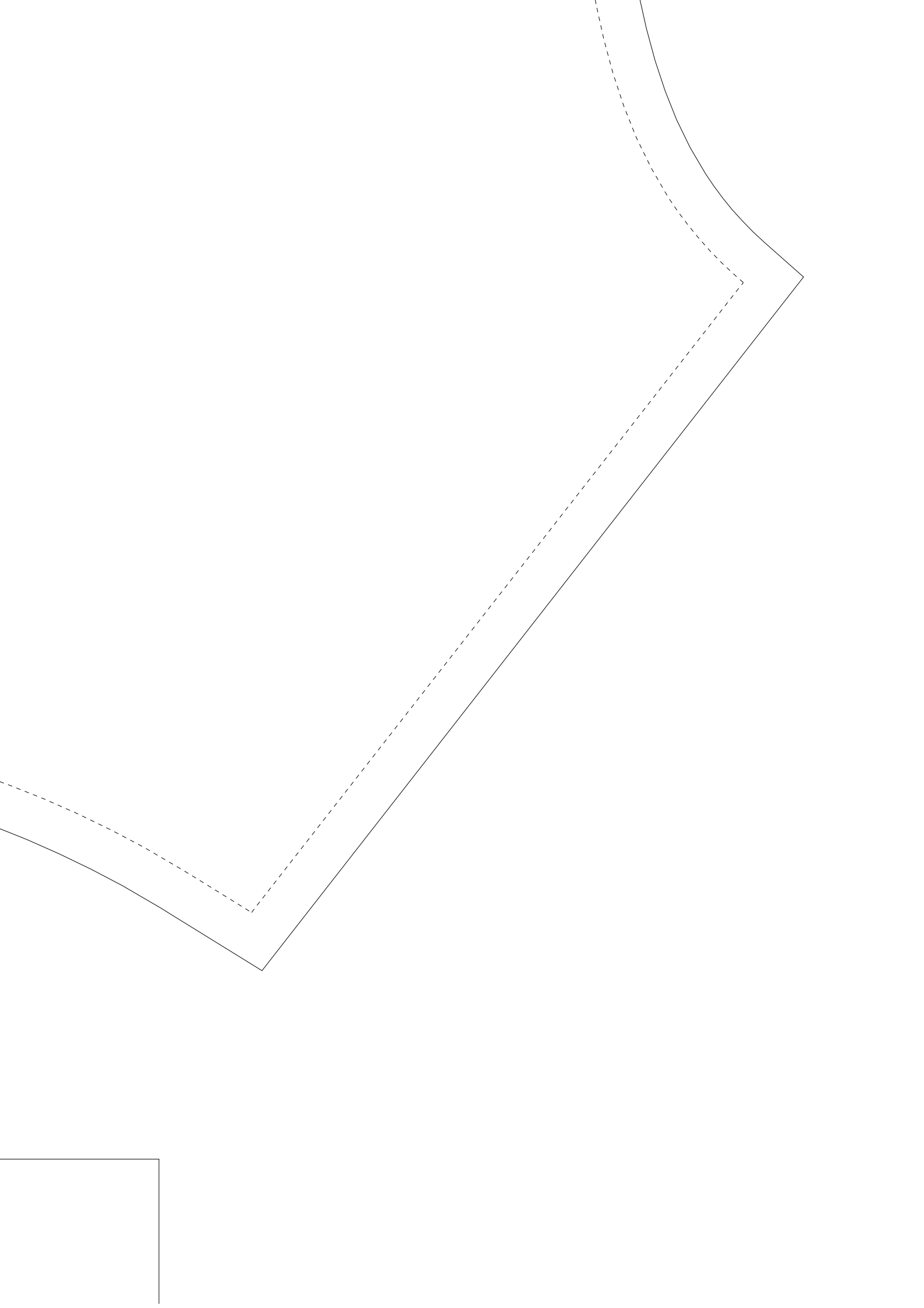

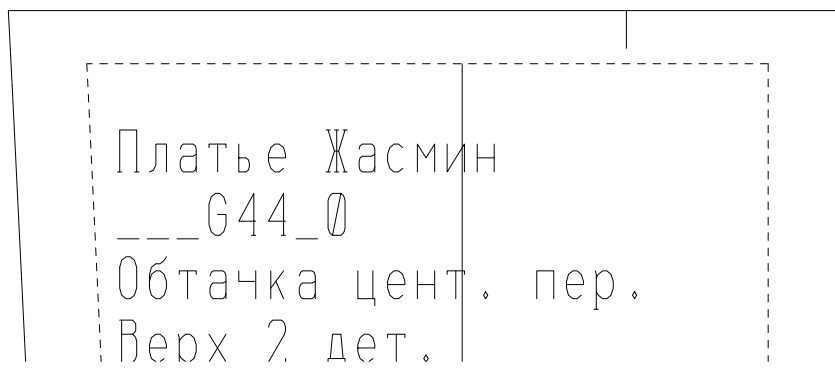

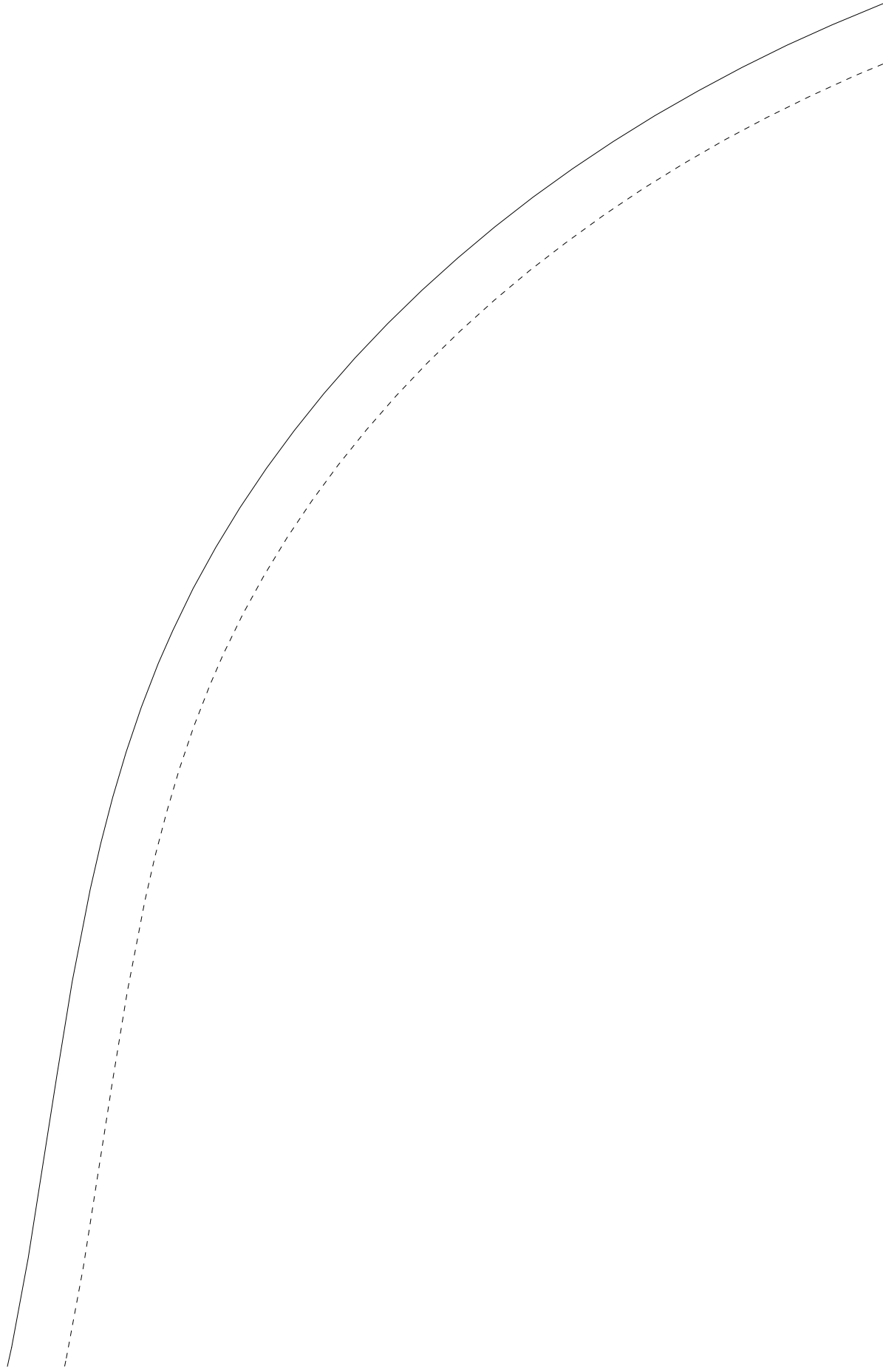



Платье Жасмин

___G44_0

Рукав

Верх

2 деталь

