

Плат

Нижн
Верх

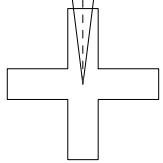

ть е Жасмин

046_0

няя часть переда

х 2 дет.

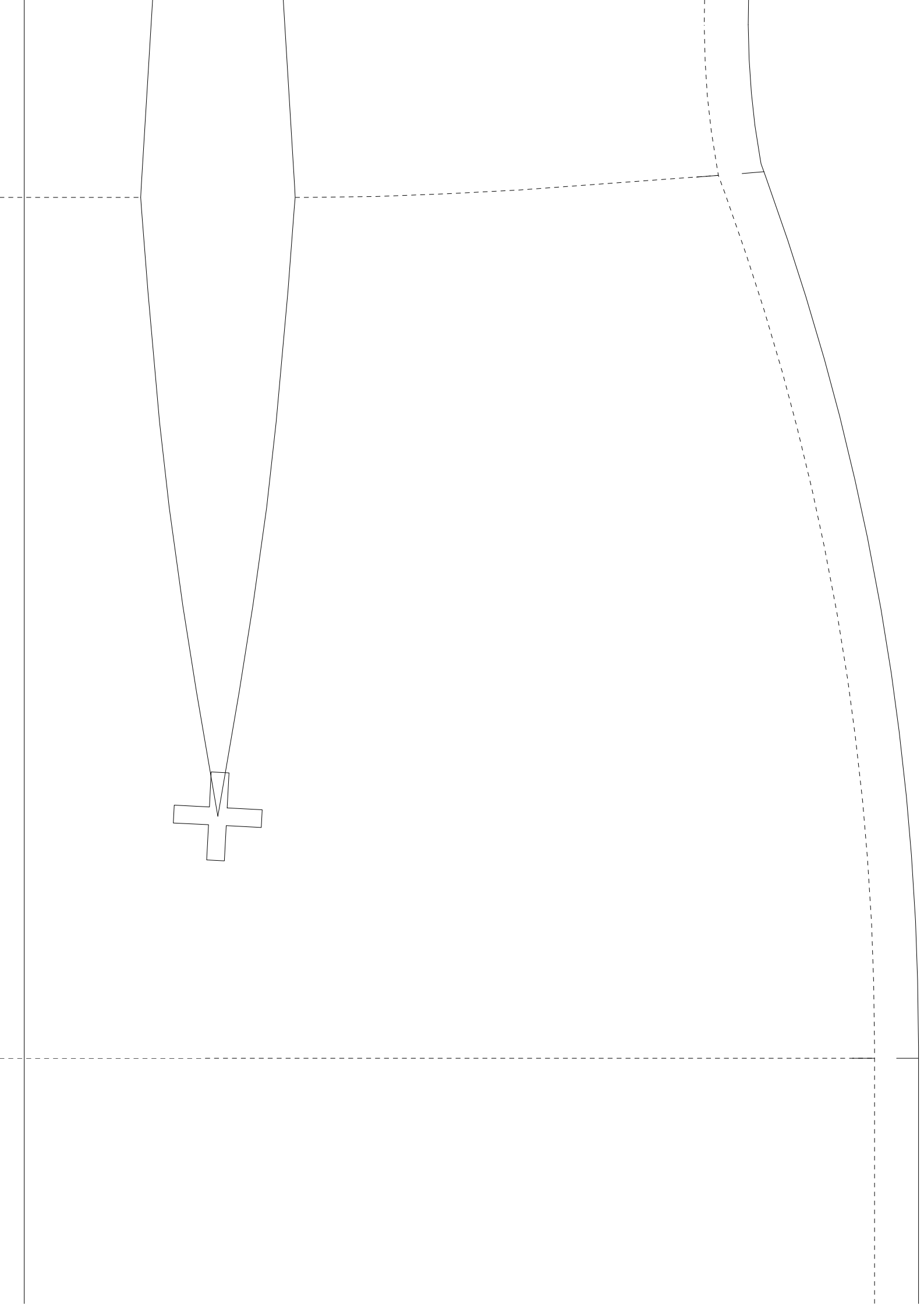

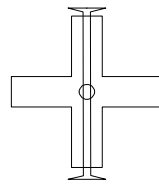
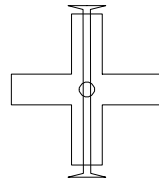
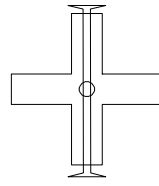
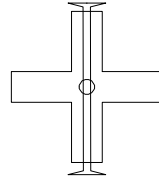
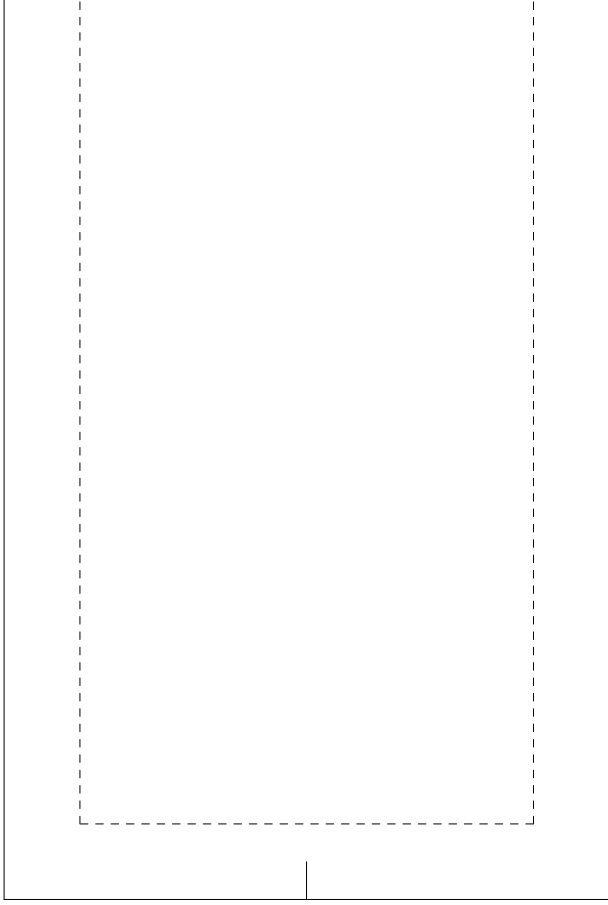

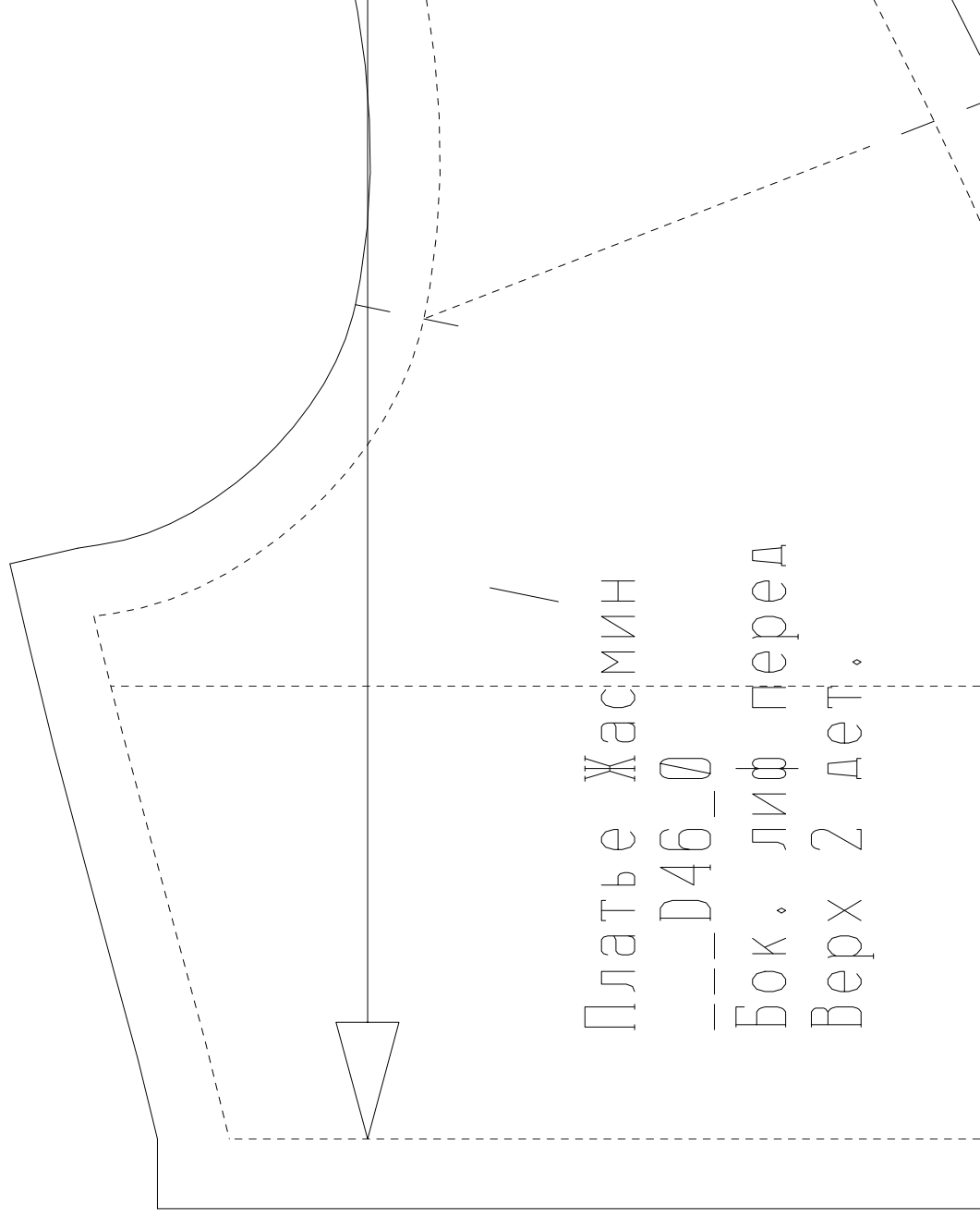

Платье Жасмин

--- D46_0

Бок. лиф перед

Верх 2 дет.

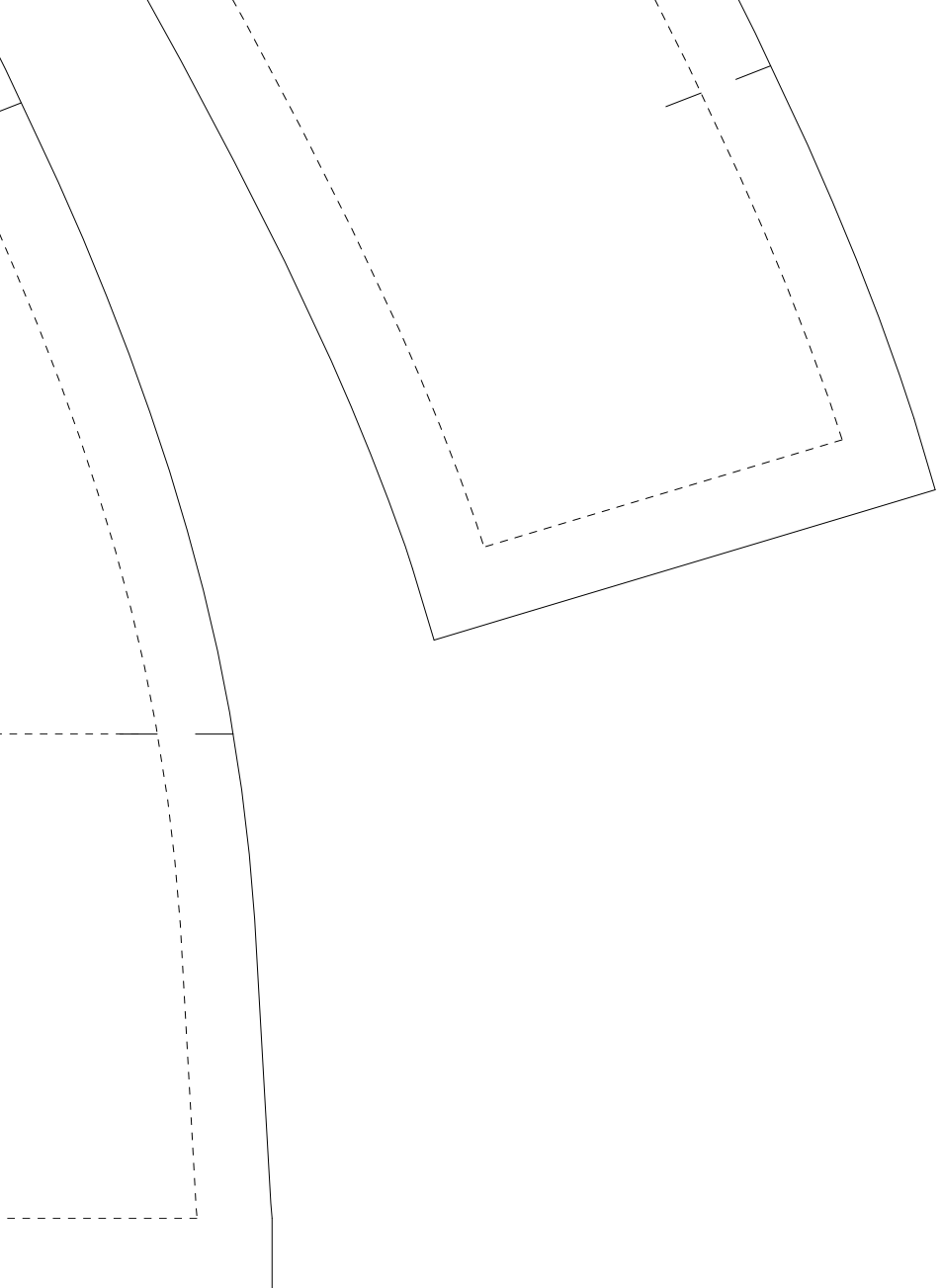

Платье
___D46___
Спинка
Верх 1

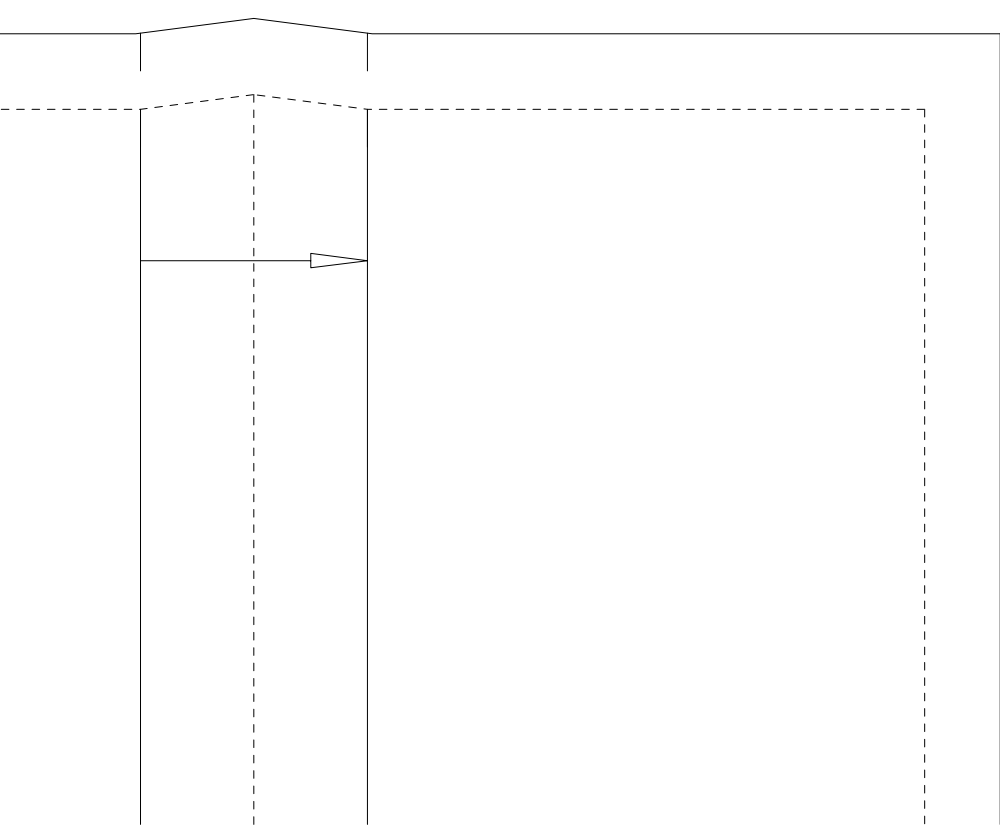

Жасмин

0

дет.

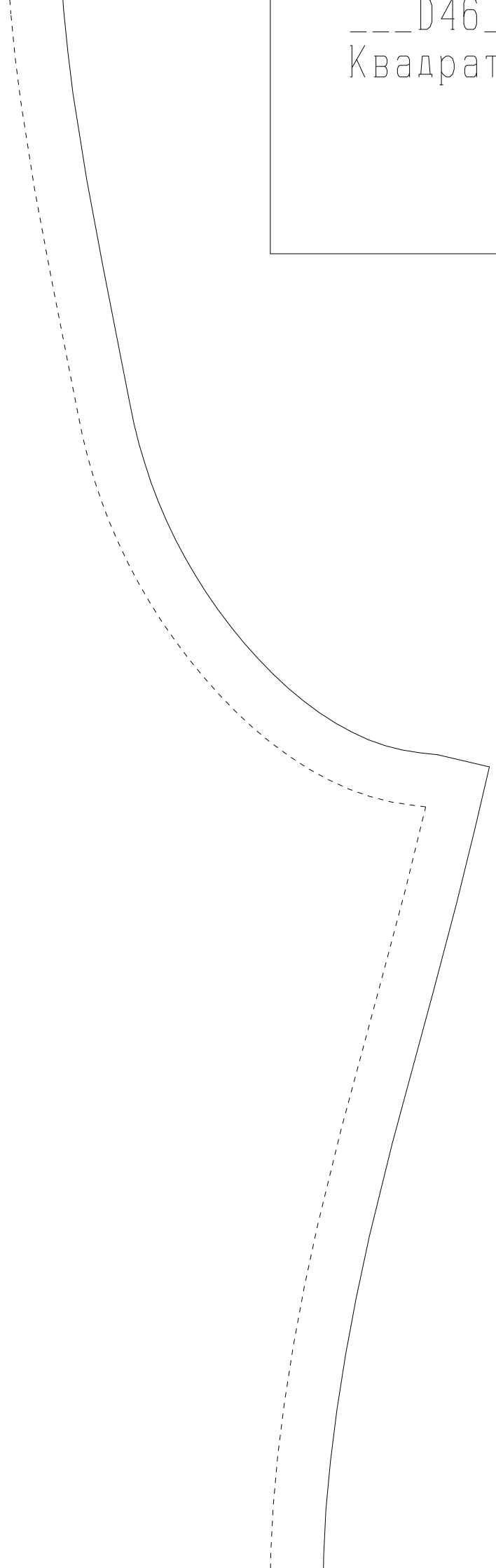
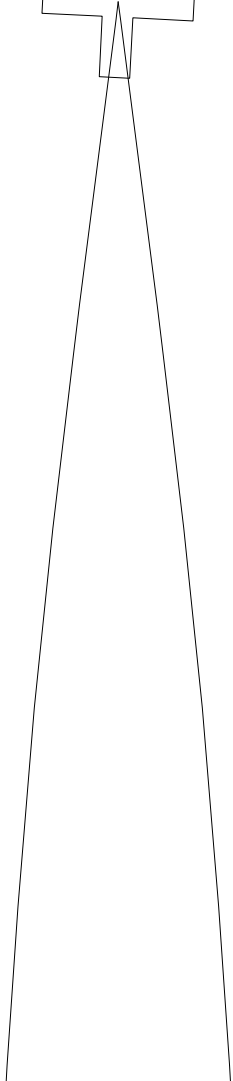
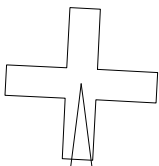

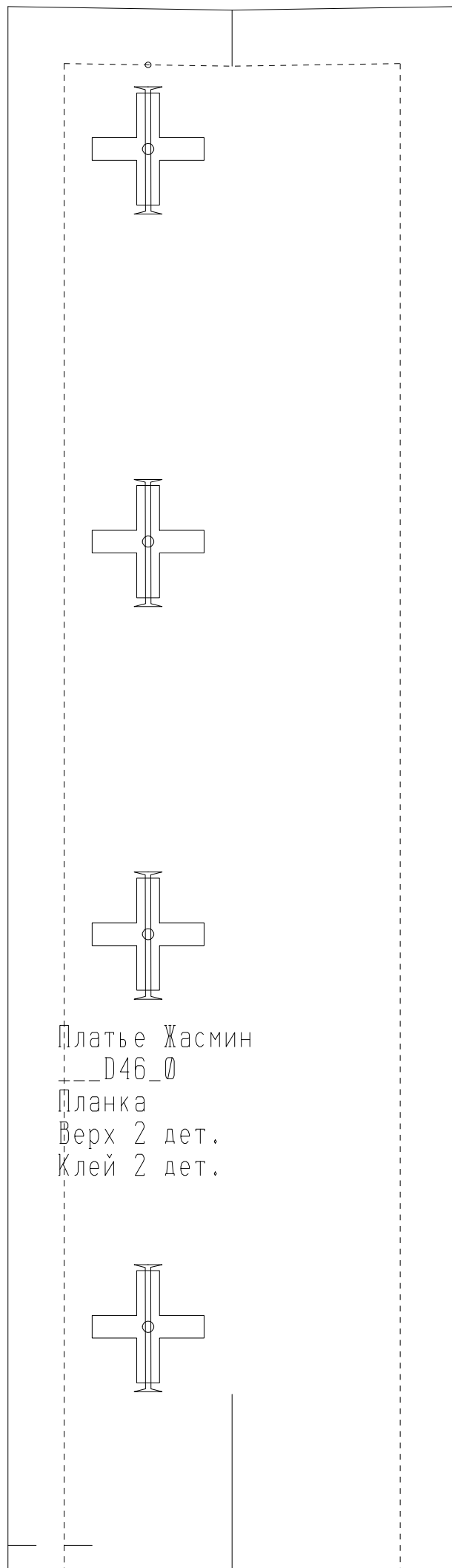

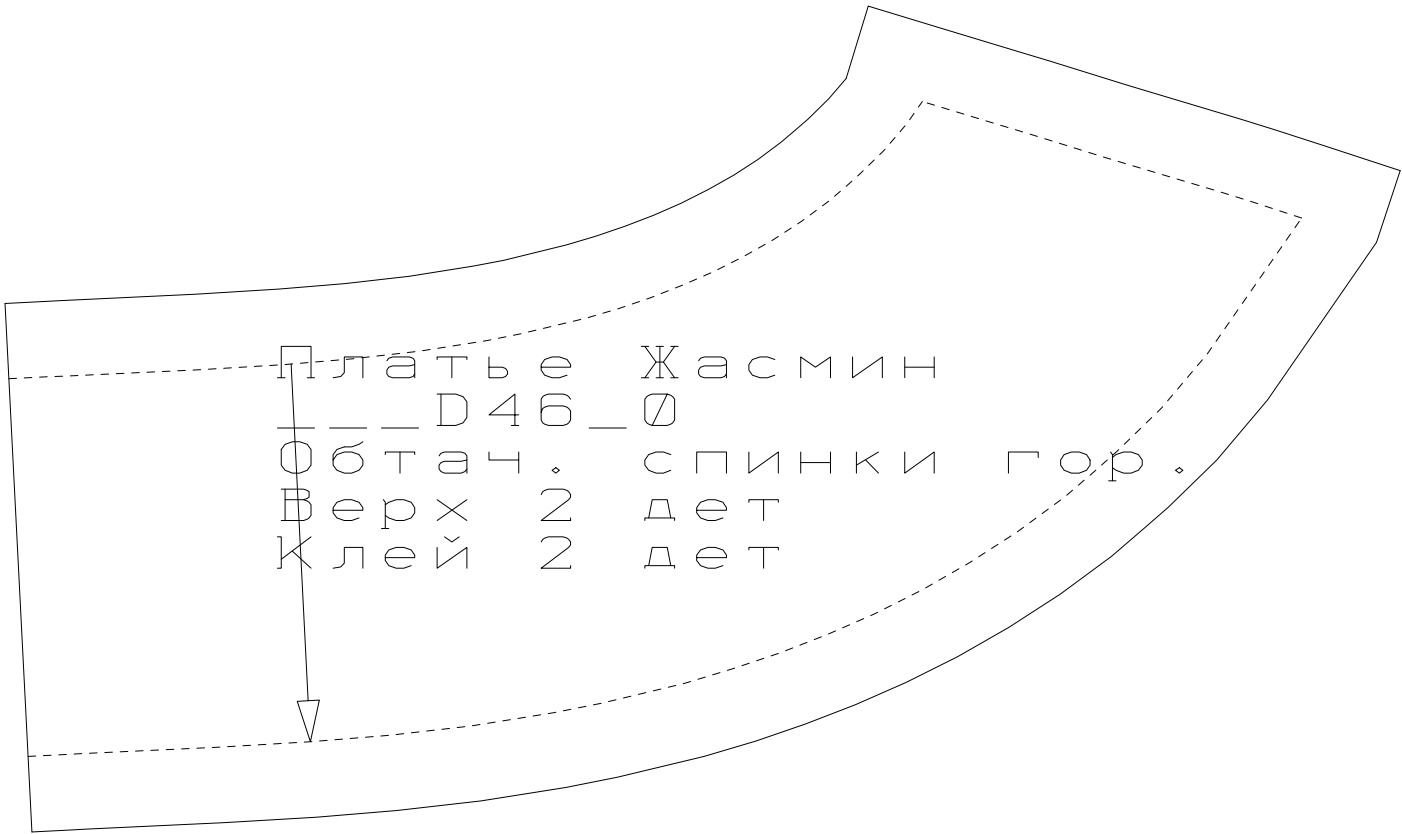

П л а т ь е Ж а с м и н
_ _ _ D 4 6 _ 0
О б т а ч . с п и н к и г о р .
В е р х 2 д е т
К л е й 2 д е т

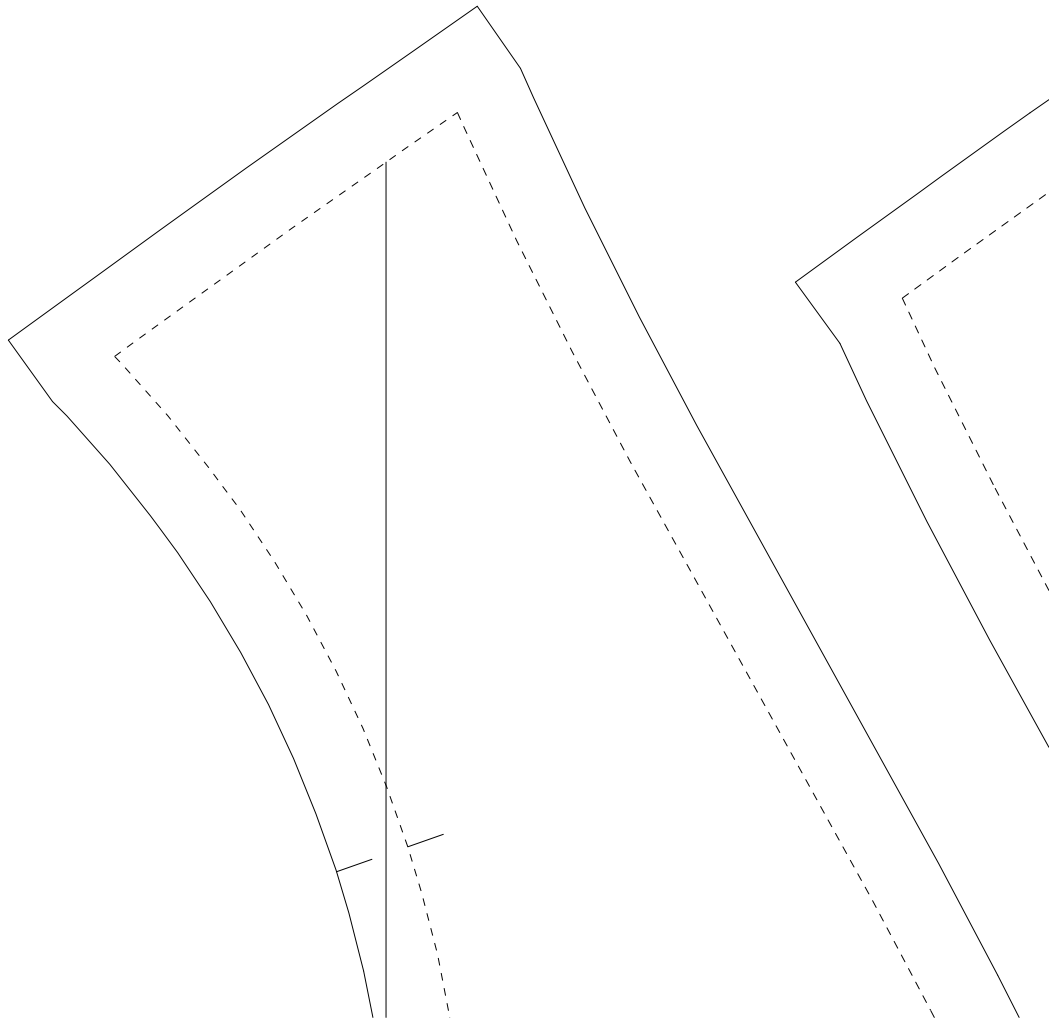

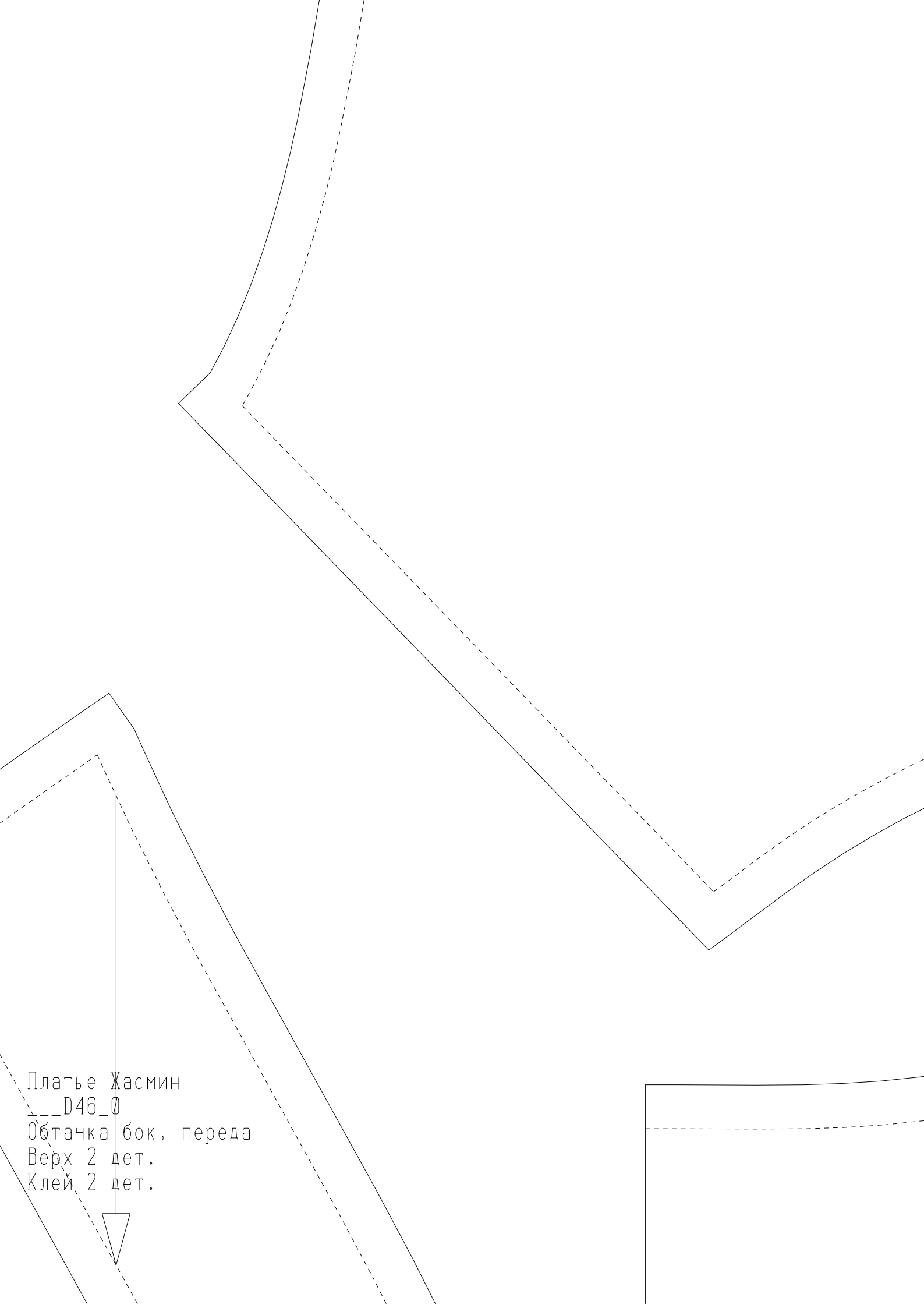

Платье Жасмин
__D46_0
Обтачка бок. переда
Верх 2 дет.
Клей 2 дет.



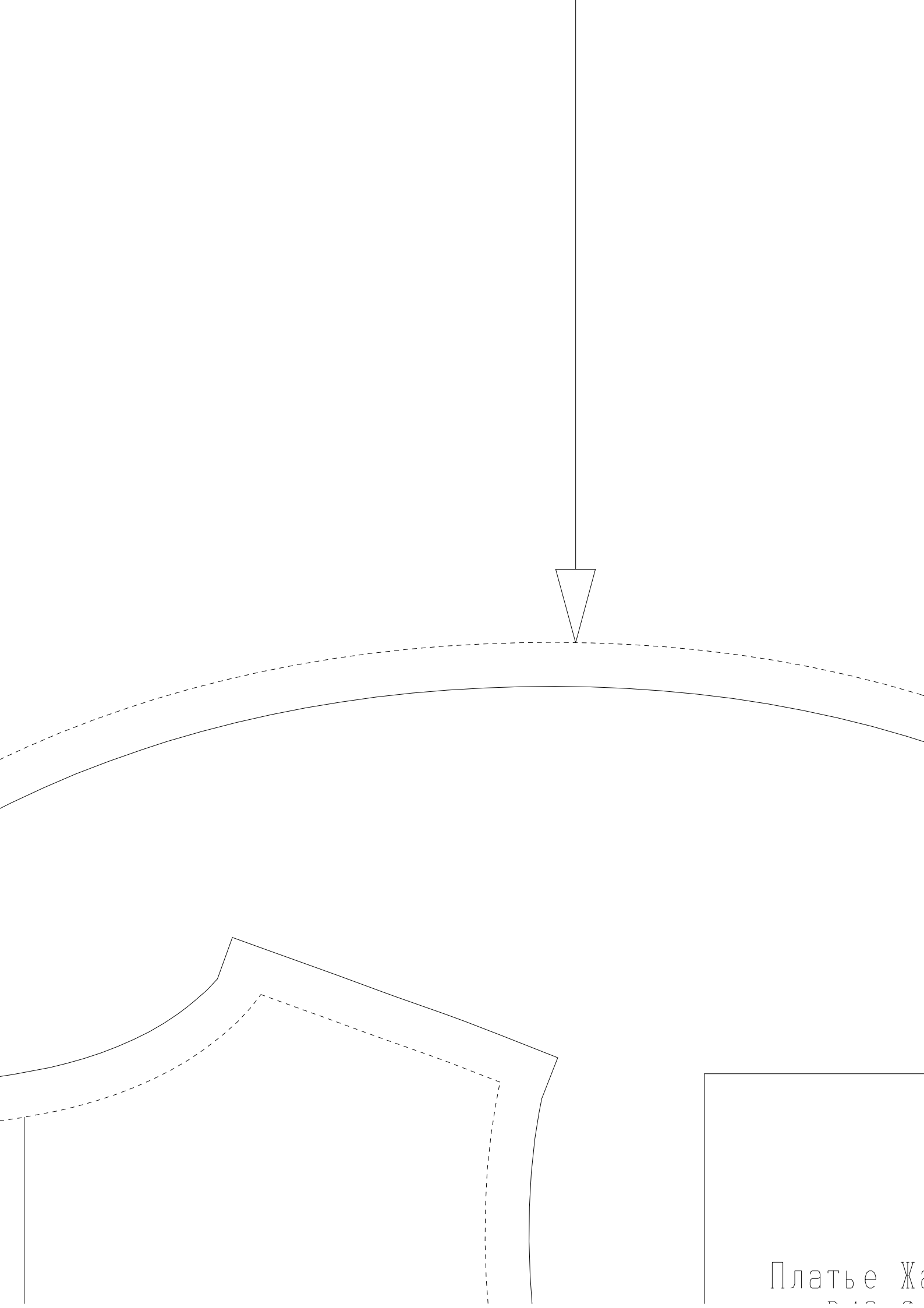

Платье Жа
рис 2

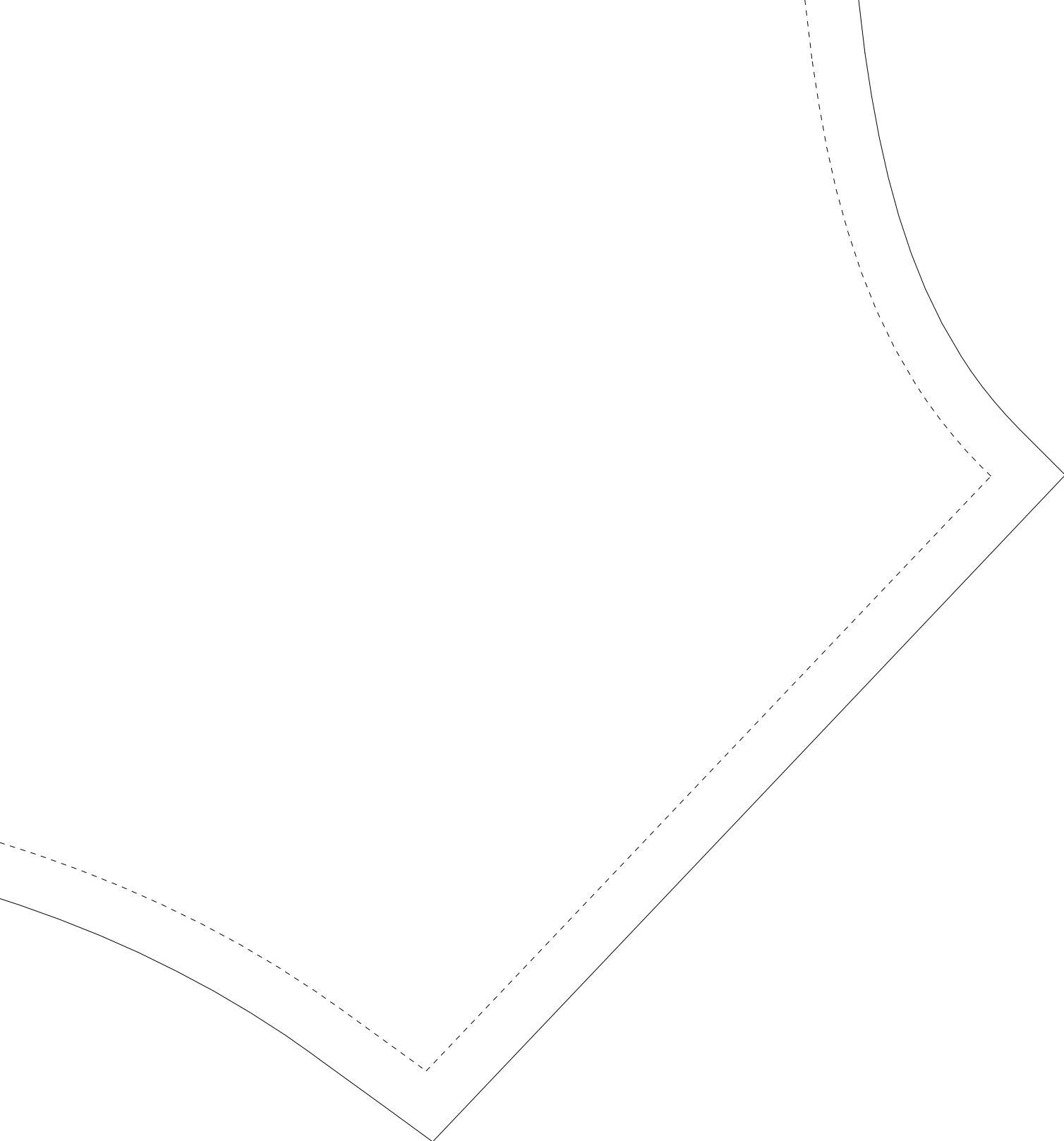

ЭСМИН



Платье Жасмин

___D46_0

Центр. лиф переда

Верх 2 дет.

Платье Жасмин

___D46_0

Обтачка цент. пер.

Верх 2 дет.

Клей 2 дет. ▾

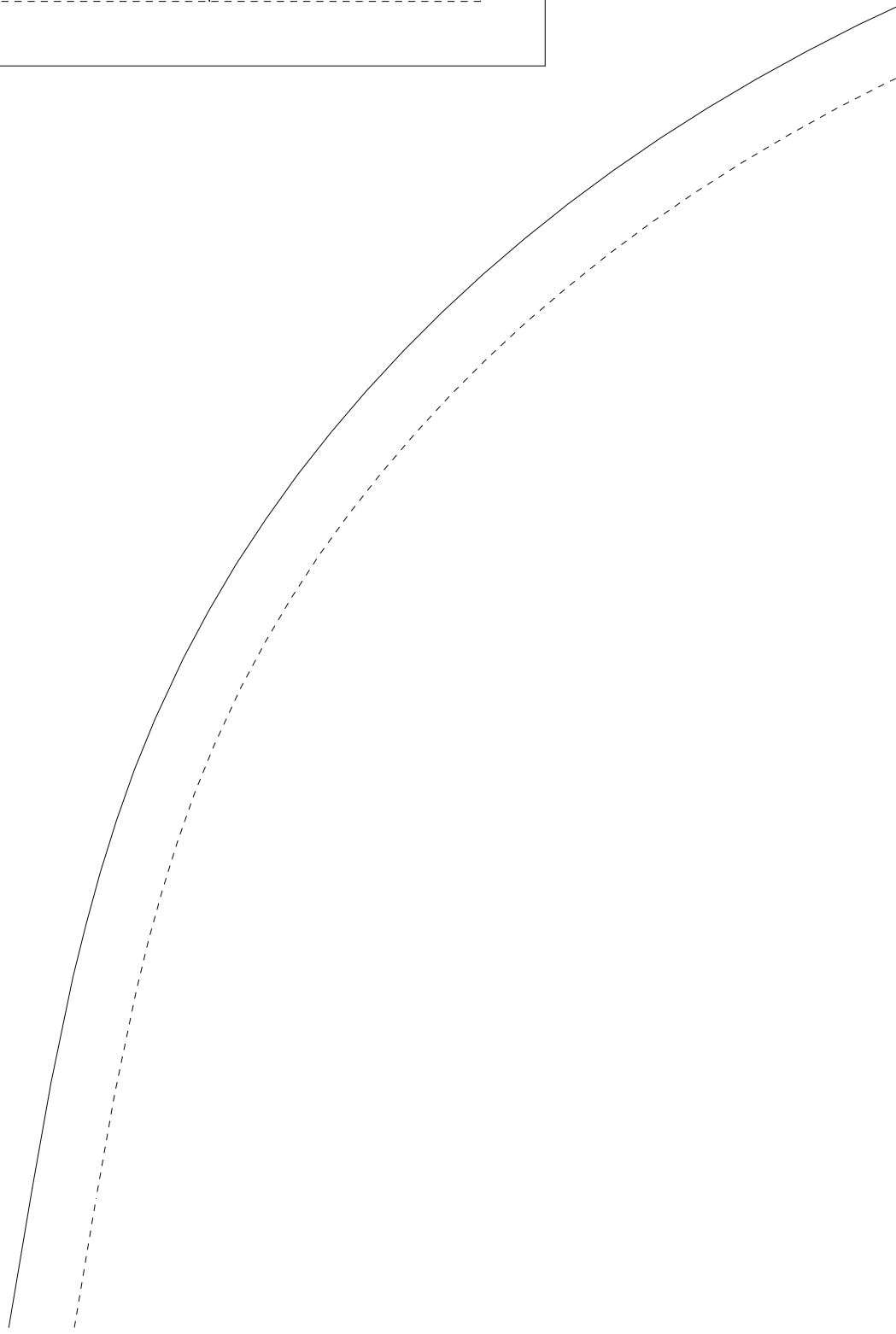

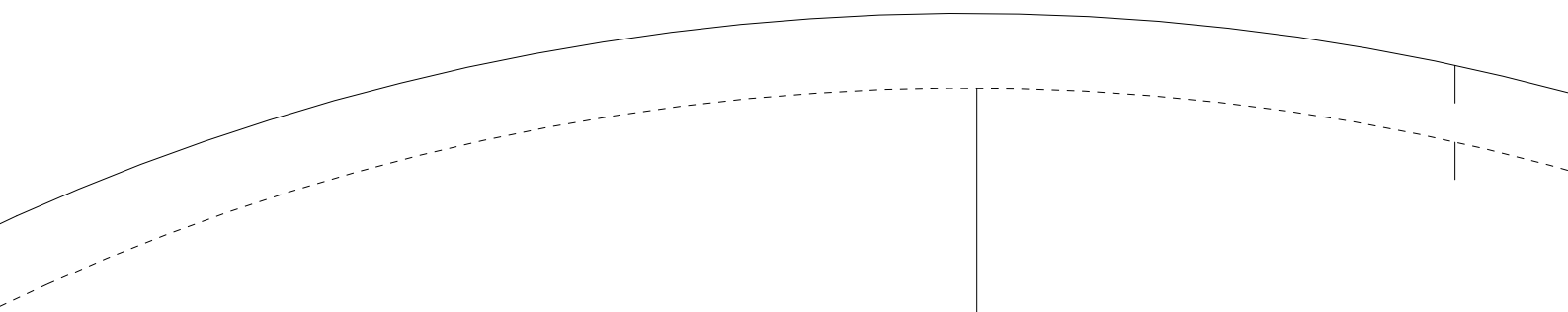

Платье Жасмин

___D46_0

Рукав

Верх

2 деталь

