

Пла

---  
Ниж

Вер

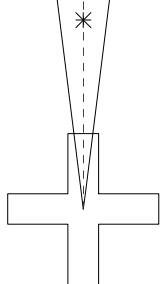

ть е Жасмин

D44\_0

няя часть переда

х 2 дет.

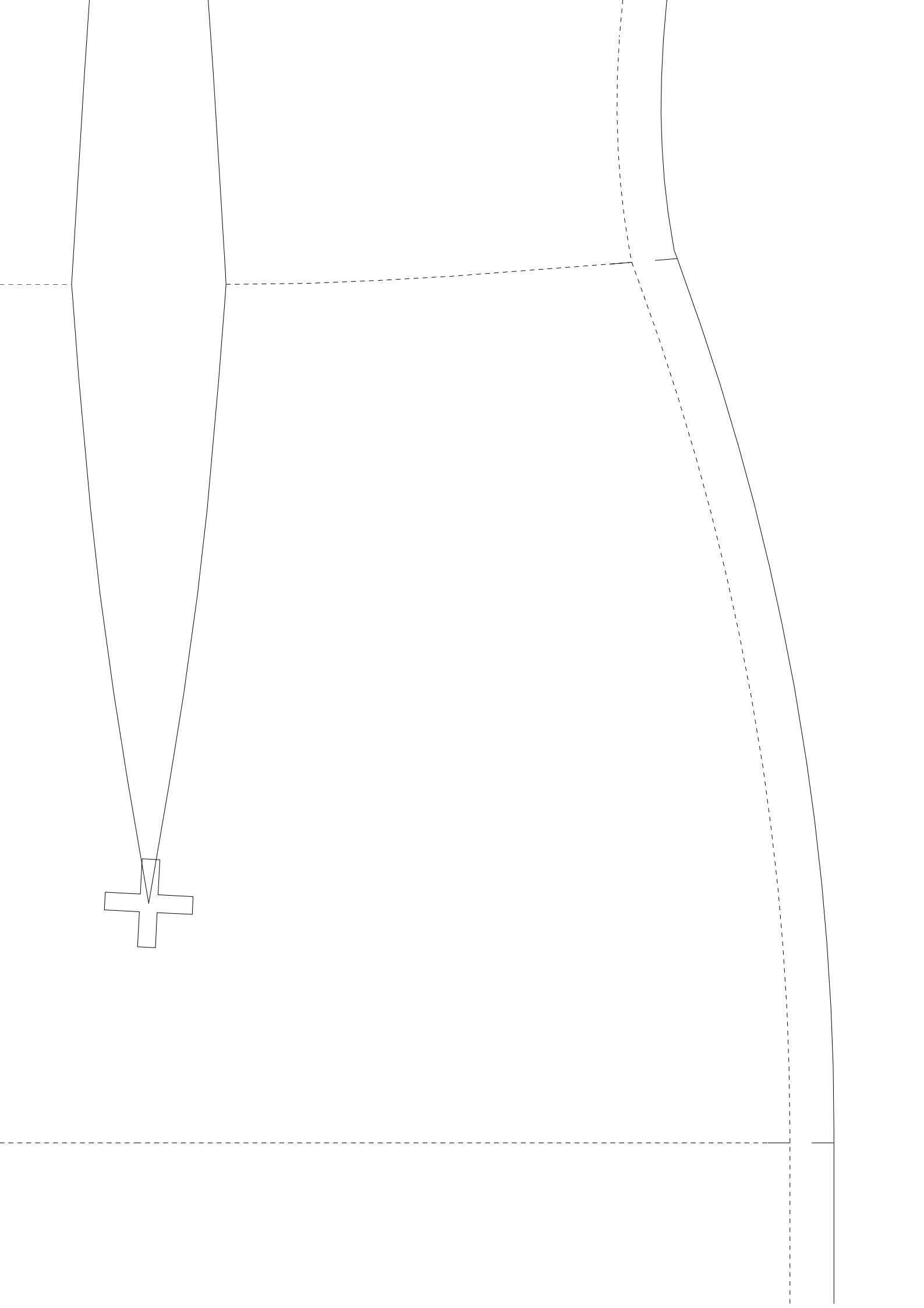

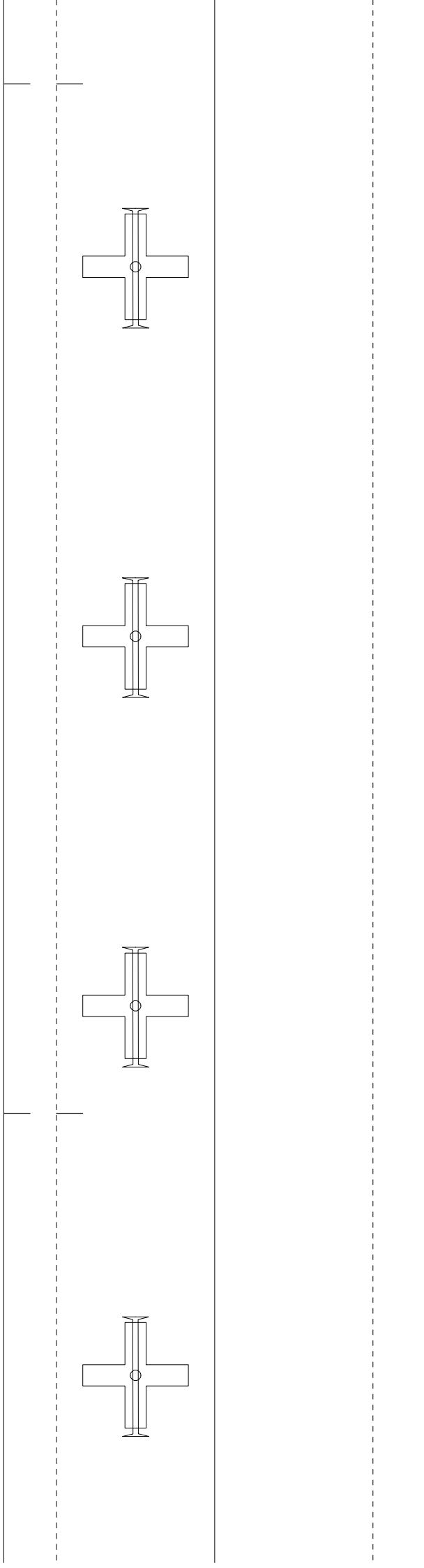
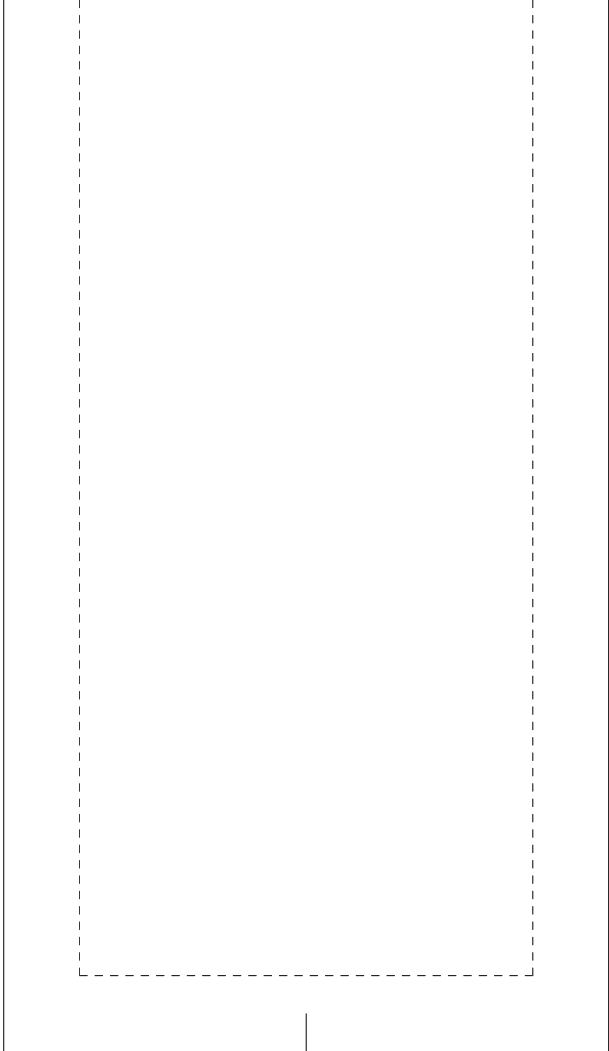

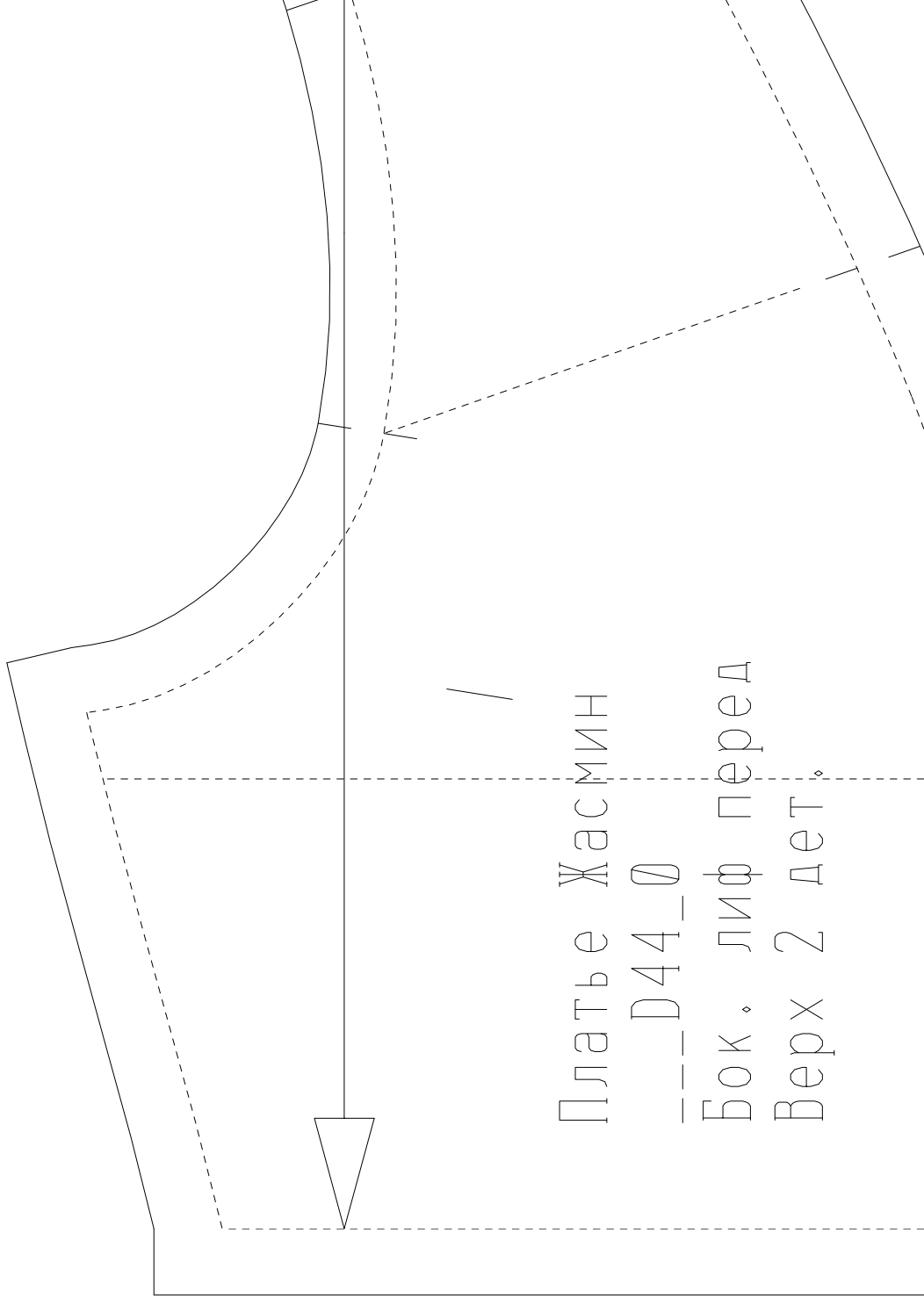

Платье Жасмин

---D44\_0

Бок. лиф перед

Верх 2 дет.

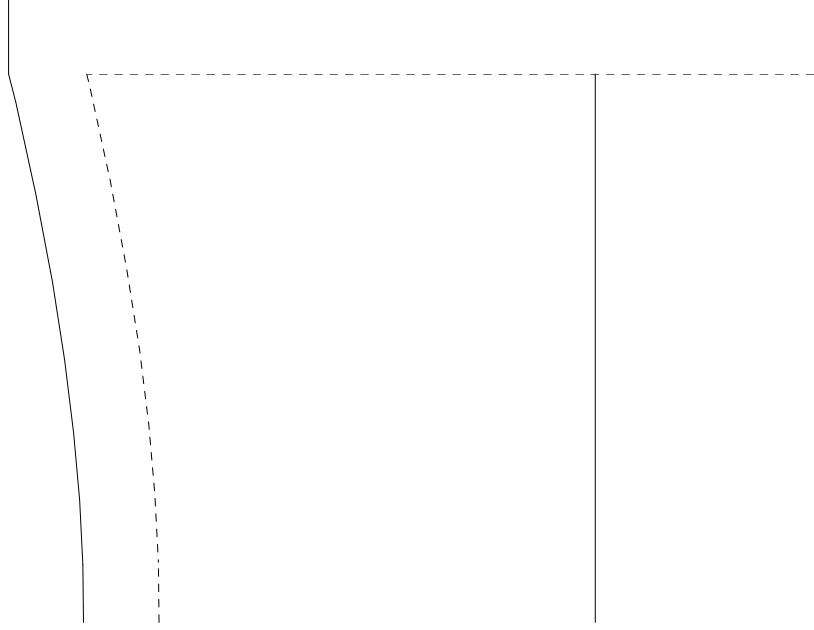

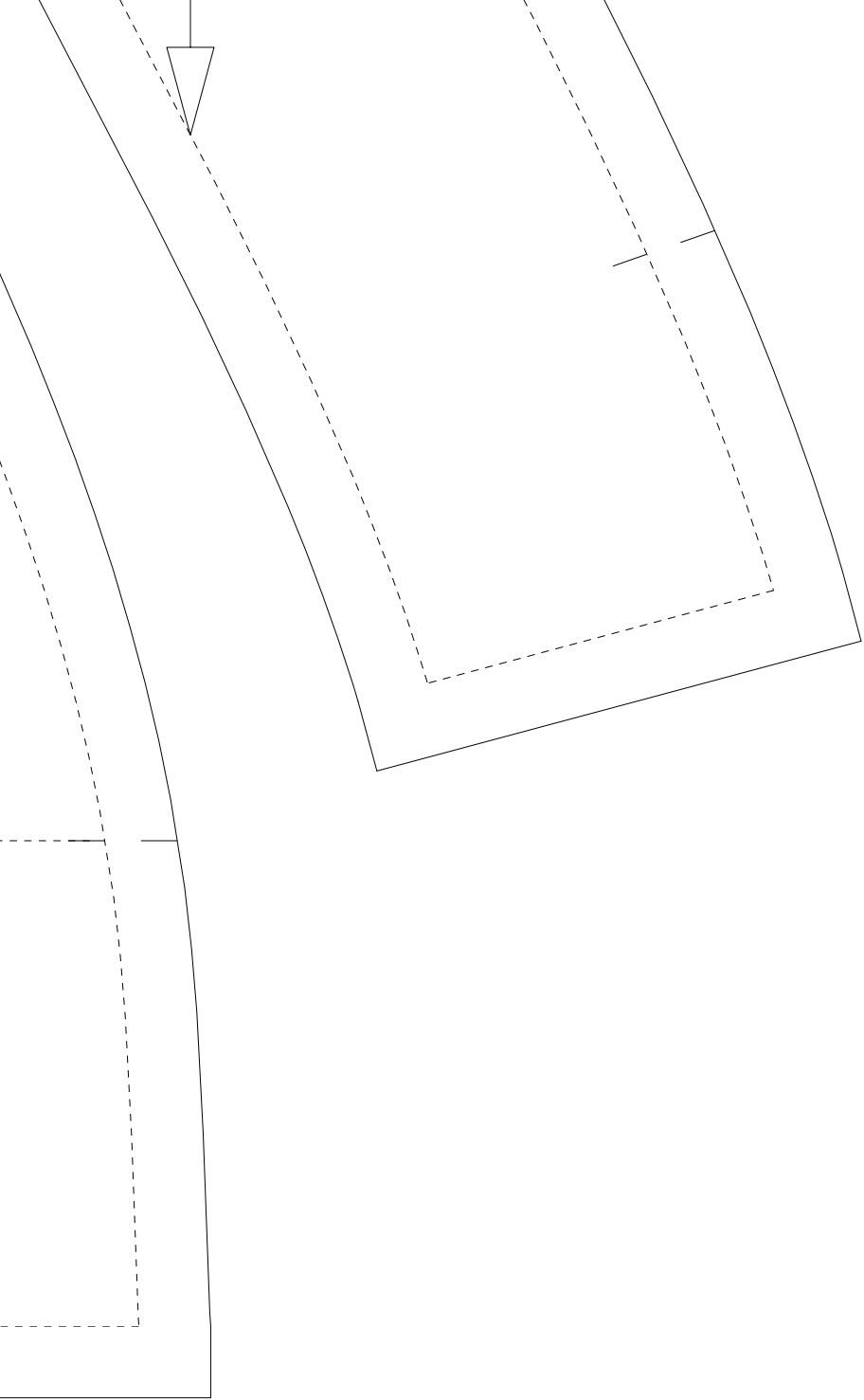

Платье Жа  
\_\_\_D44\_0  
Спинка  
Верх 1 д

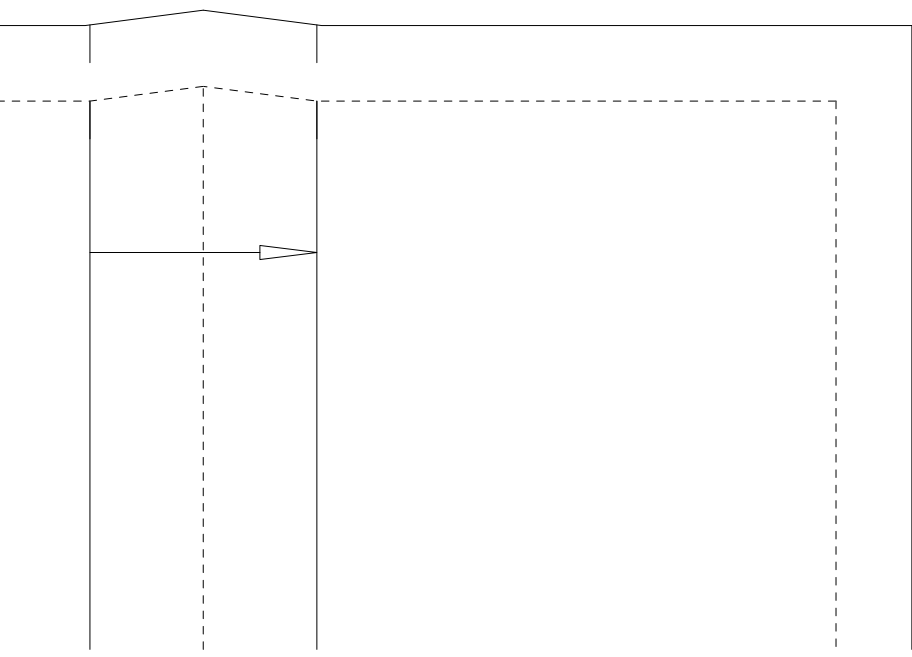

Платье Жасм  
\_\_\_D44\_0  
Квадрат 10

ЖАСМИН

дет.

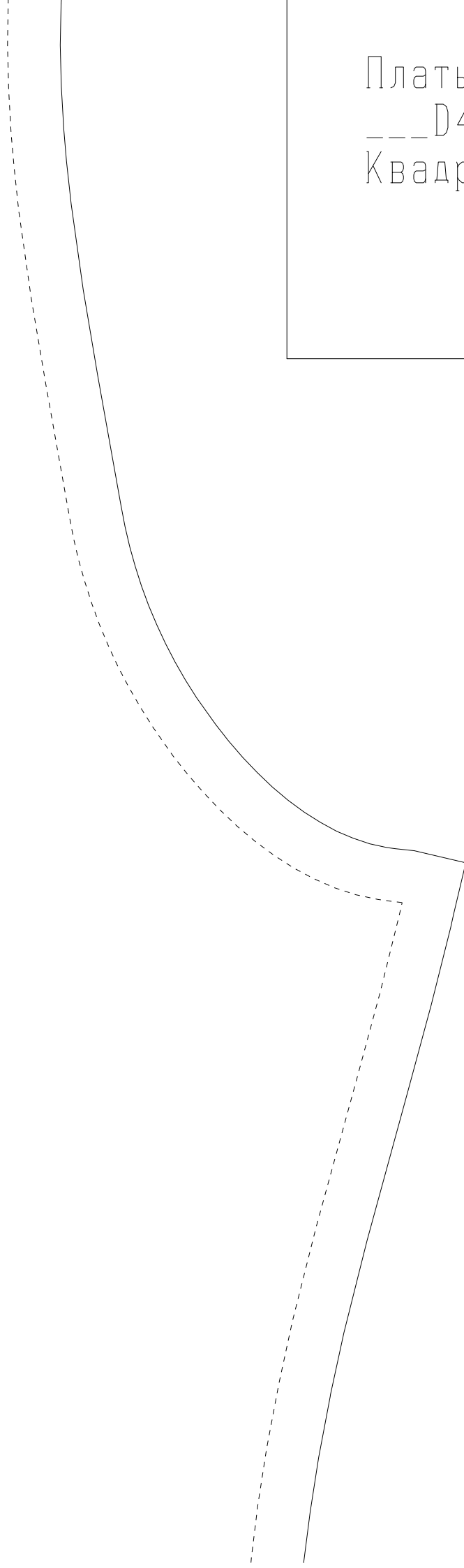
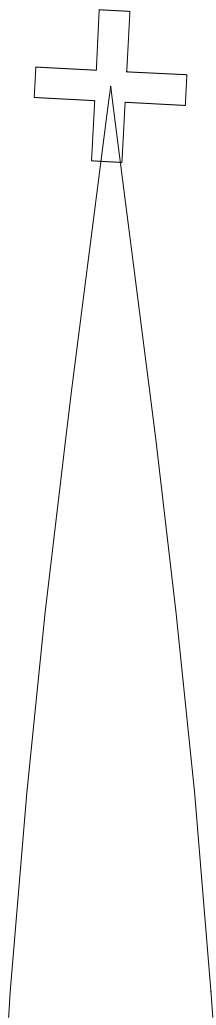

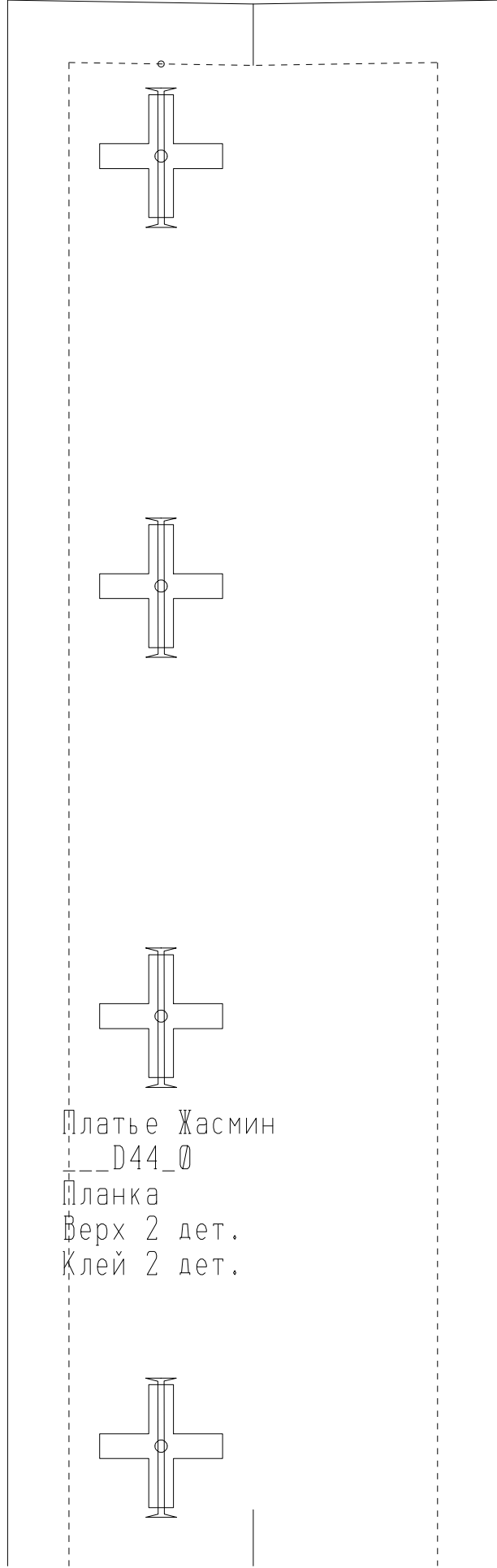
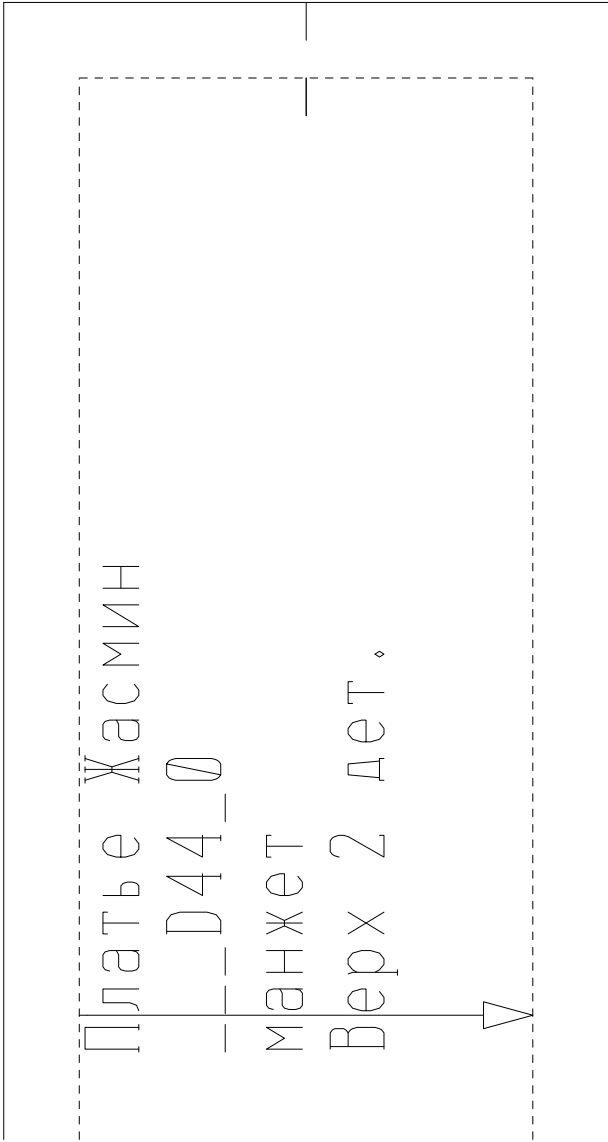



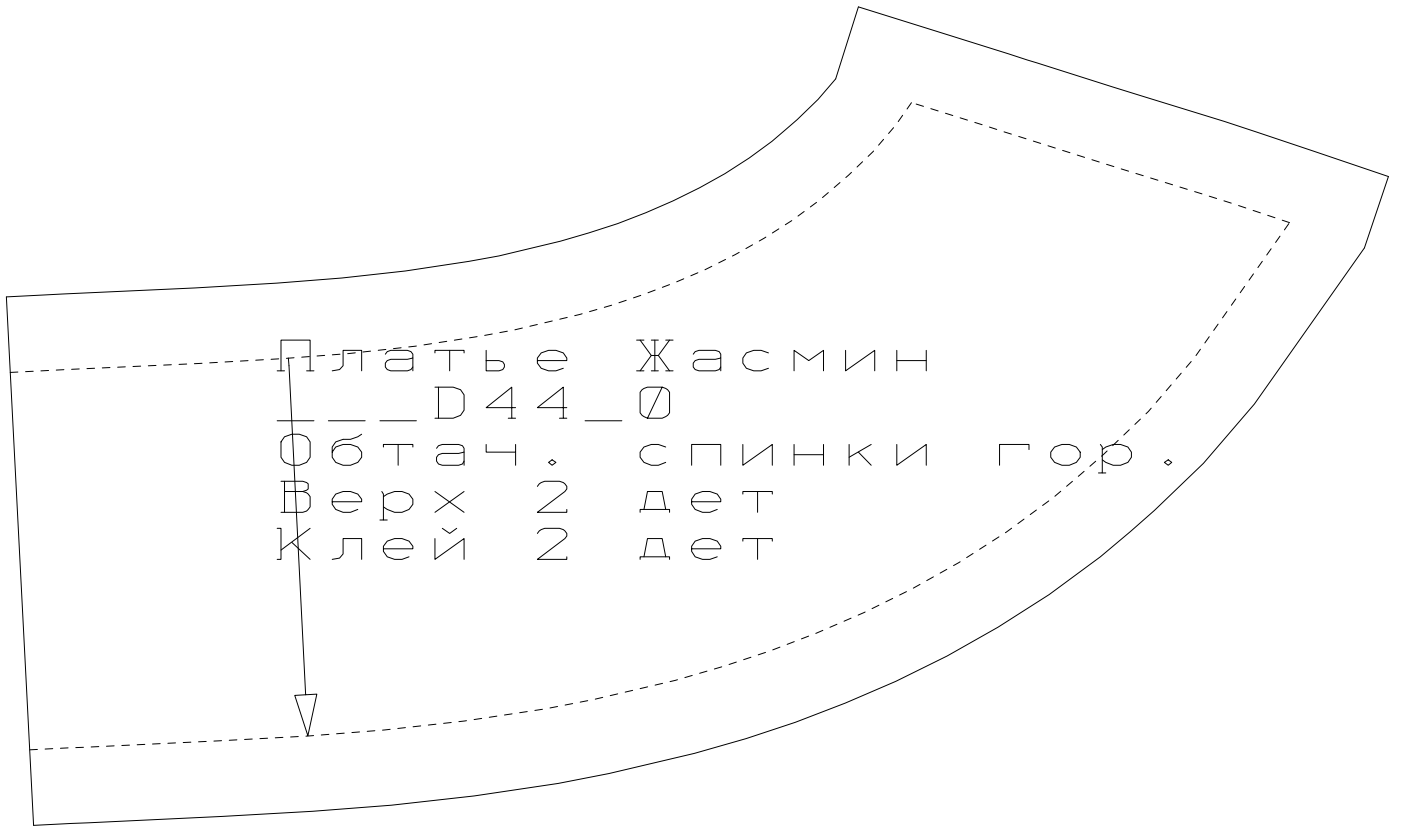

Платье Жасмин

— D44\_0

Обтач. спинки гор.

Верх 2 дет

Клей 2 дет

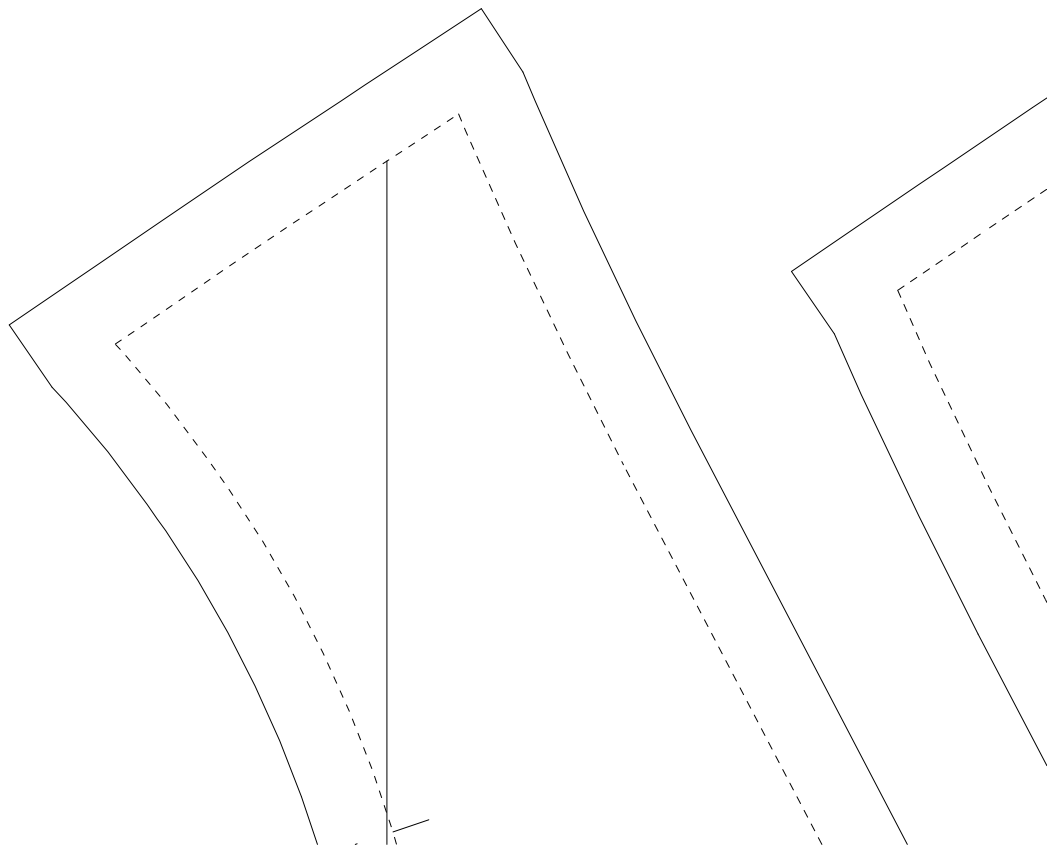



Платье Жасмин  
D44\_0  
Обтачка бок. переда  
Верх 2 дет.  
Клей 2 дет.

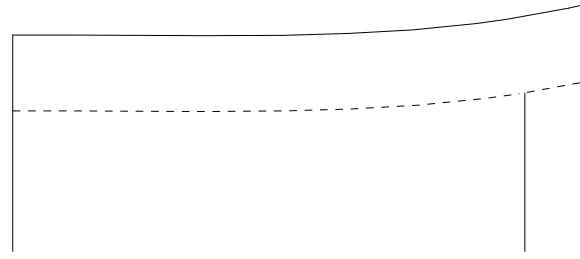

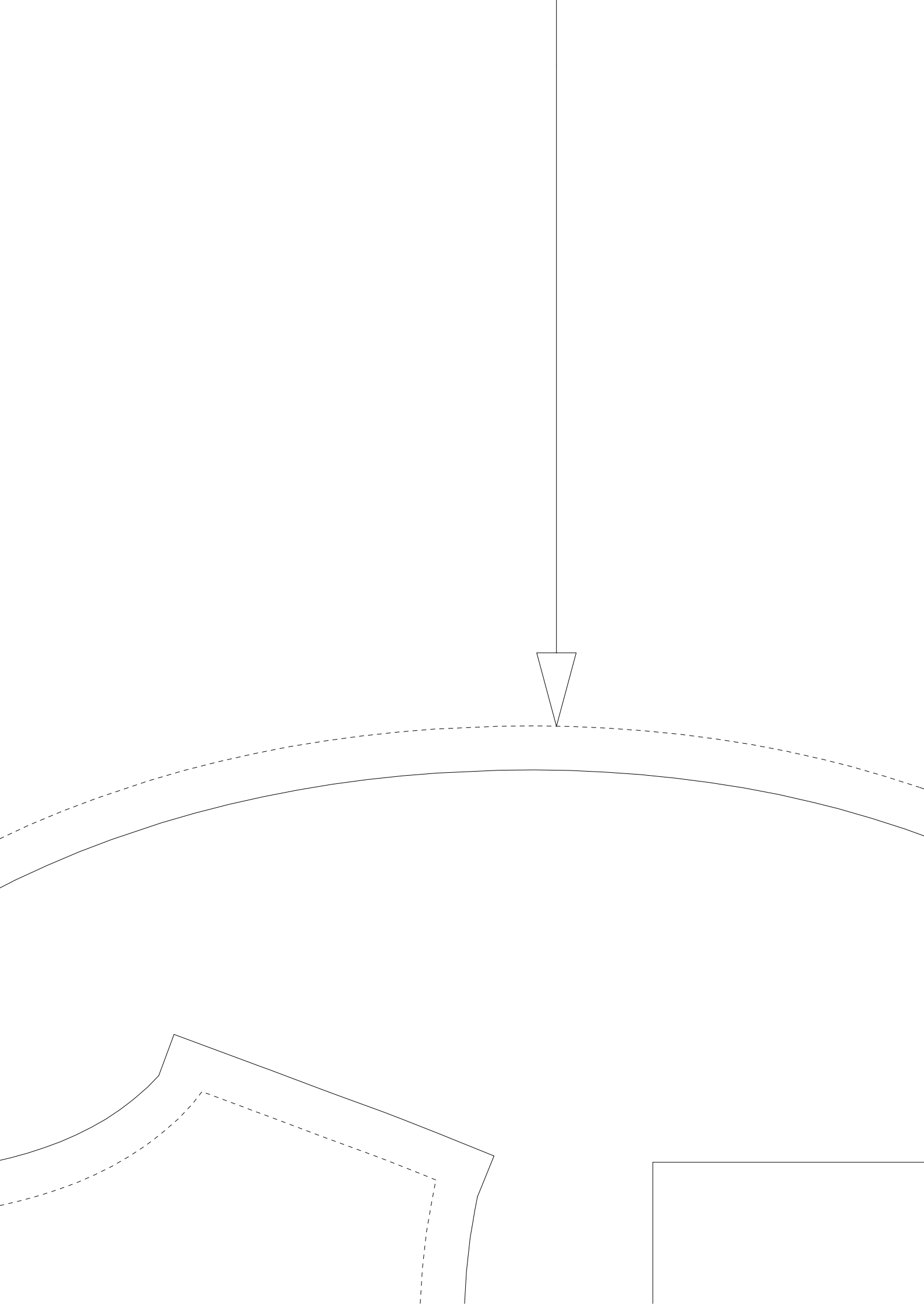

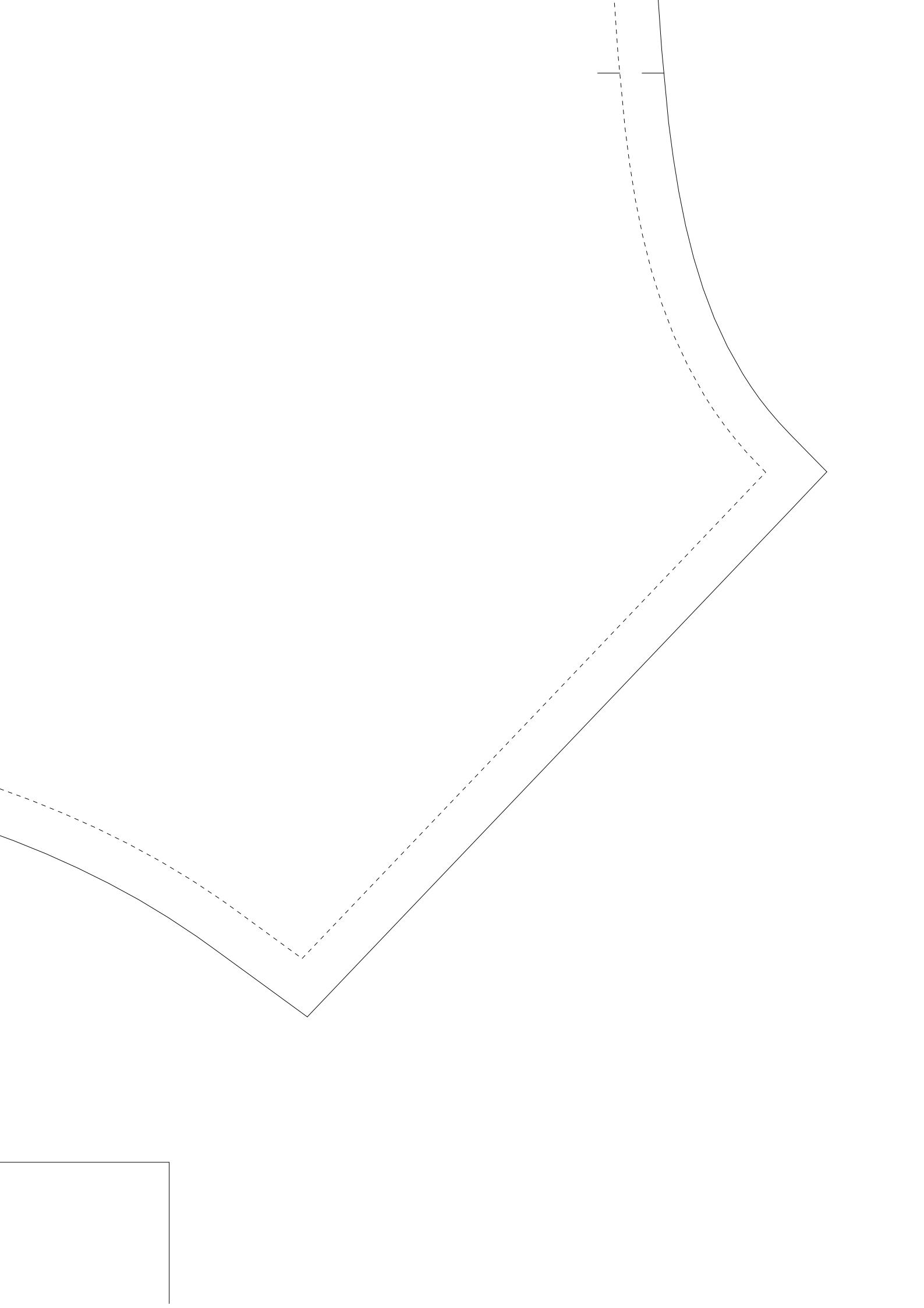



Платье Жасмин

\_\_\_D44\_0

Центр. лиф переда

Верх 2 дет.

Платье Жасмин

\_\_D44\_0

Обтачка цент. пер.

Верх 2 дет.

Клей 2 дет. ▽

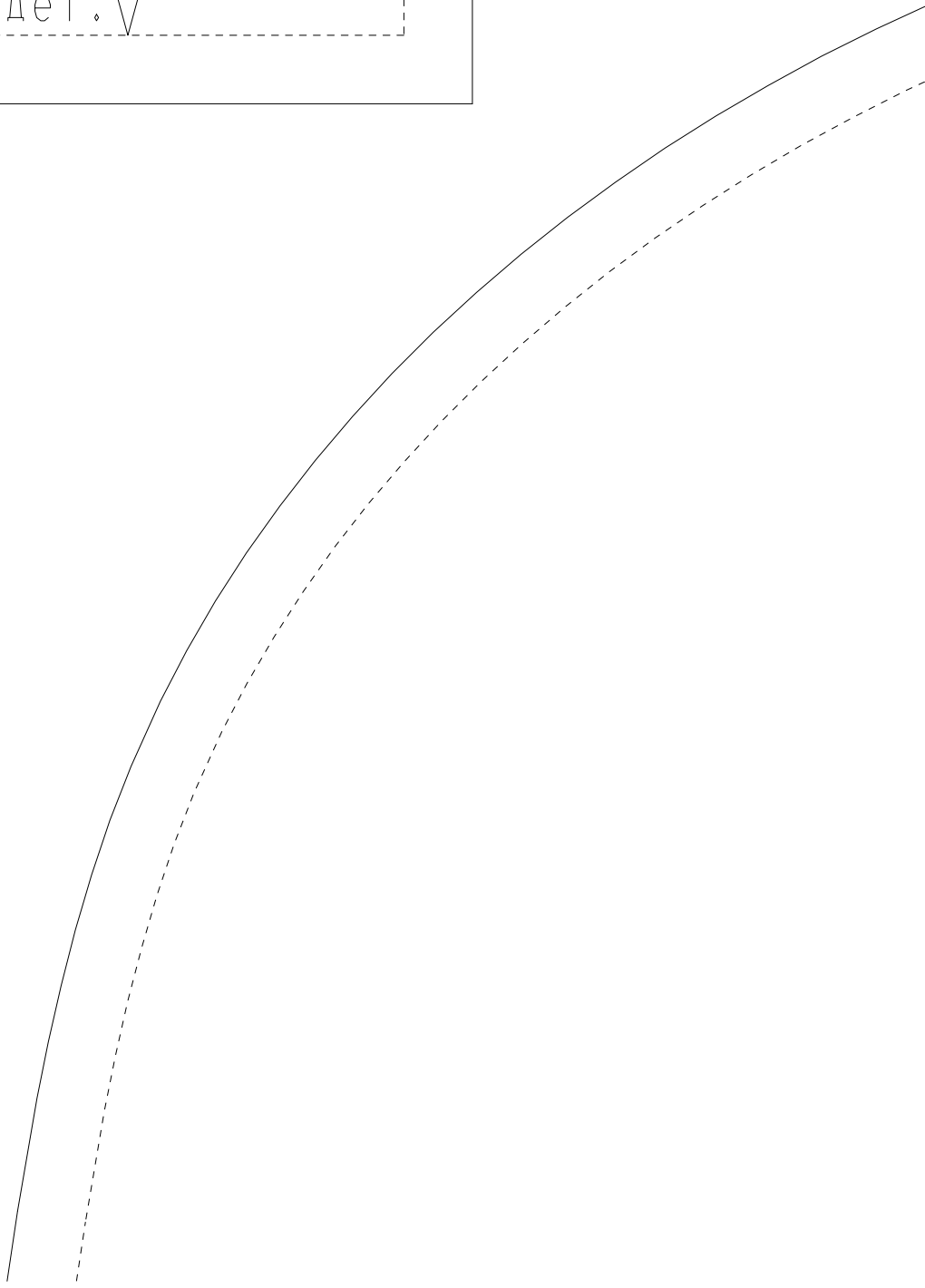

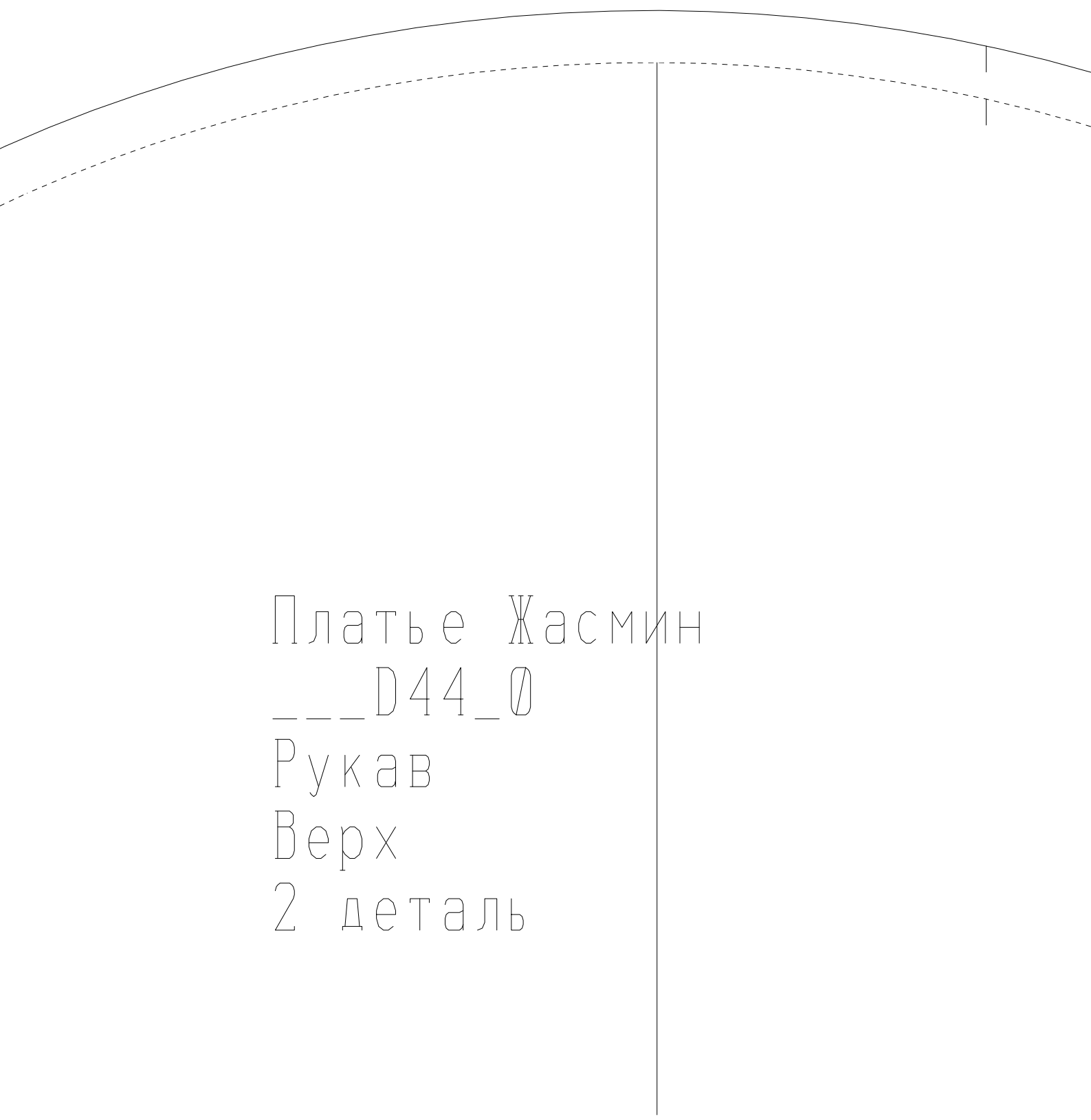

Платье Жасмин

\_\_\_D44\_0

Рукав

Верх

2 деталь

