

Платье Жасмин

___D42_0

Нижняя часть переда

Верх 2 дет.

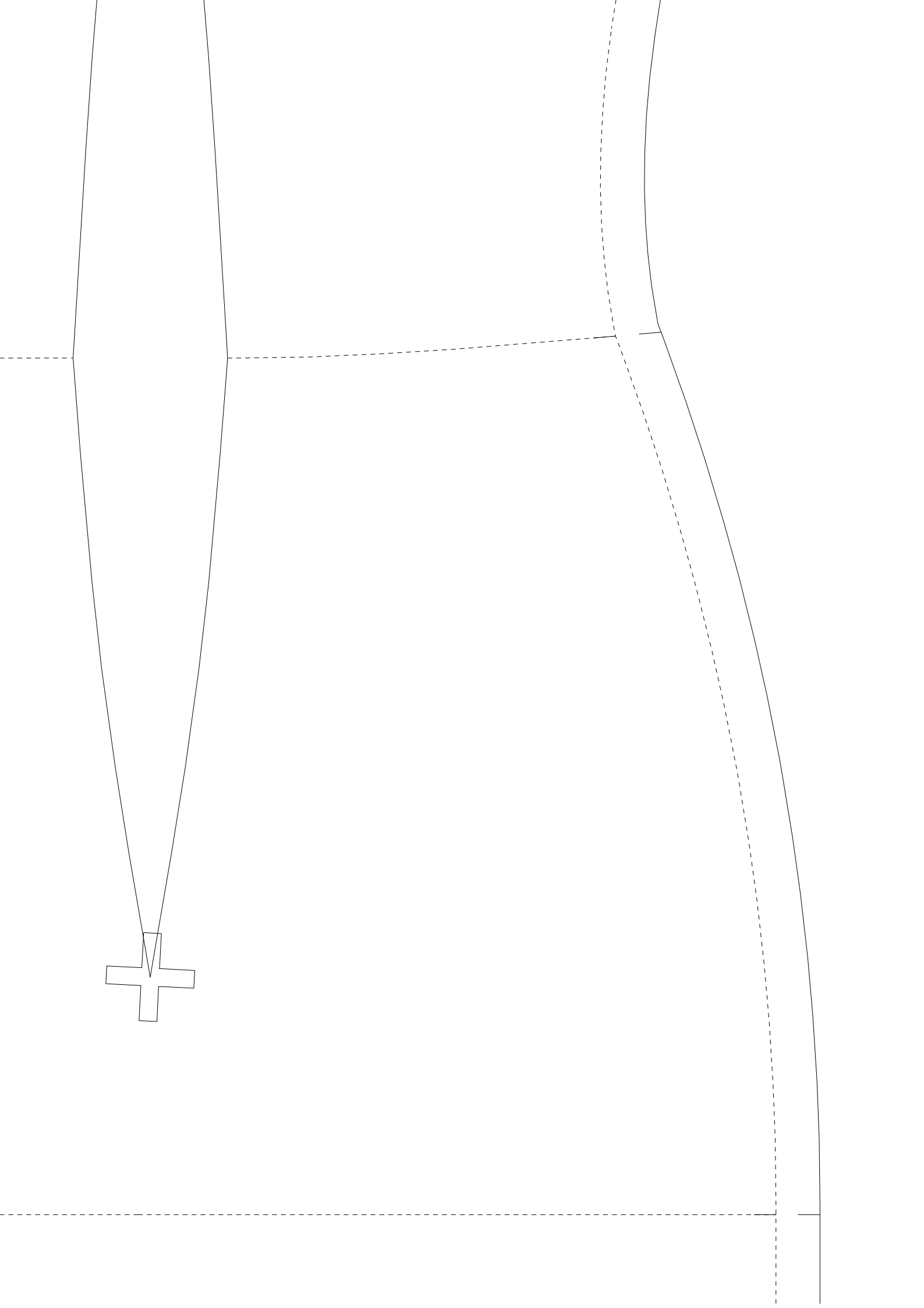

MaBe

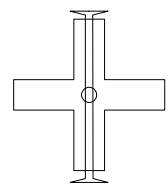
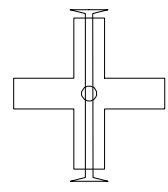
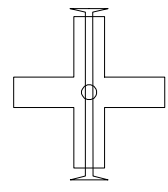
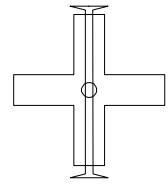
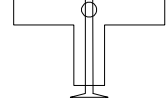

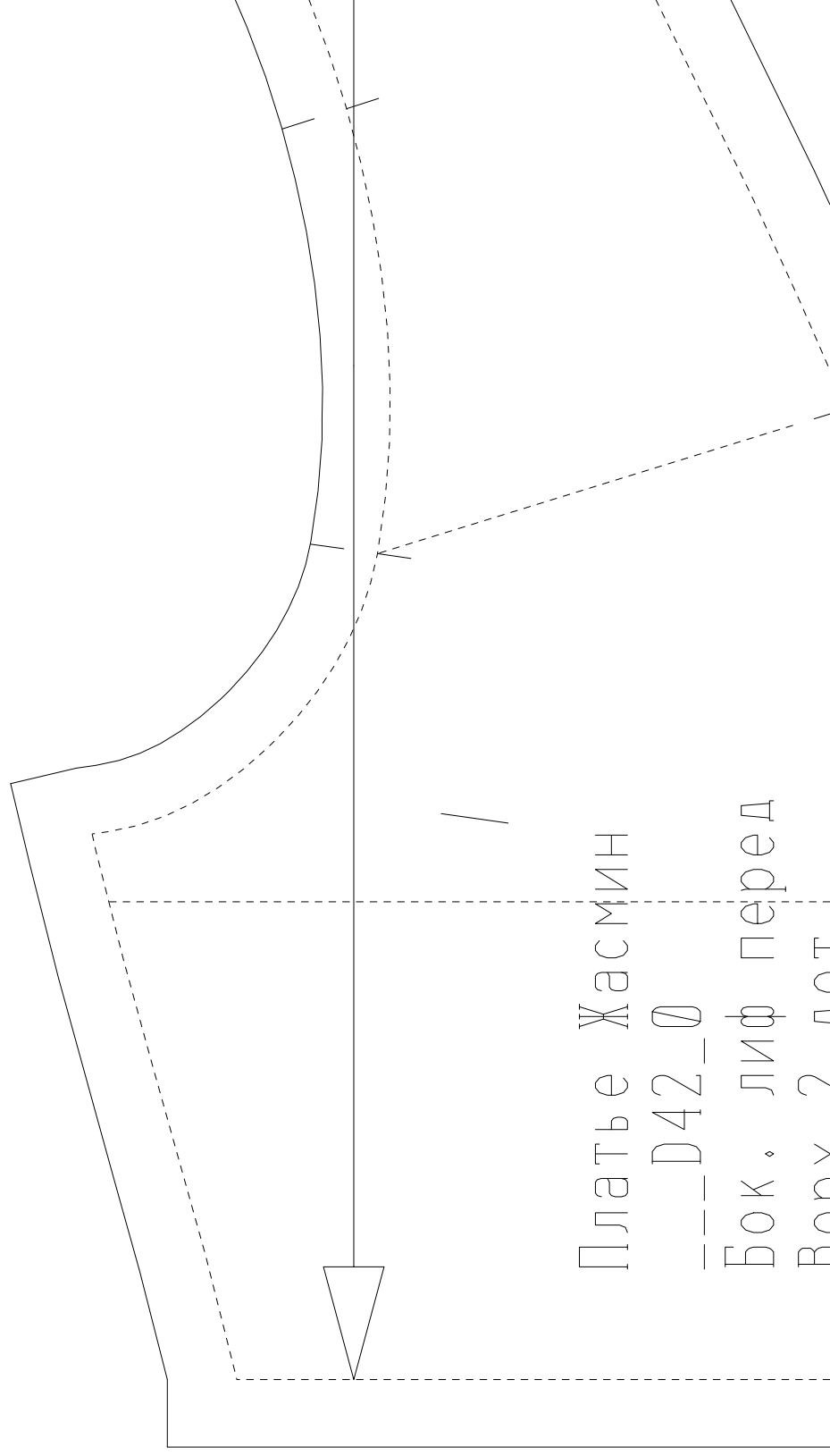

Платье Жасмин

---D42_0

Бок. лиф перед

Ворх 2 дог

Обтачка бок. переда
Верх 2 дет.
Клей 2 дет.

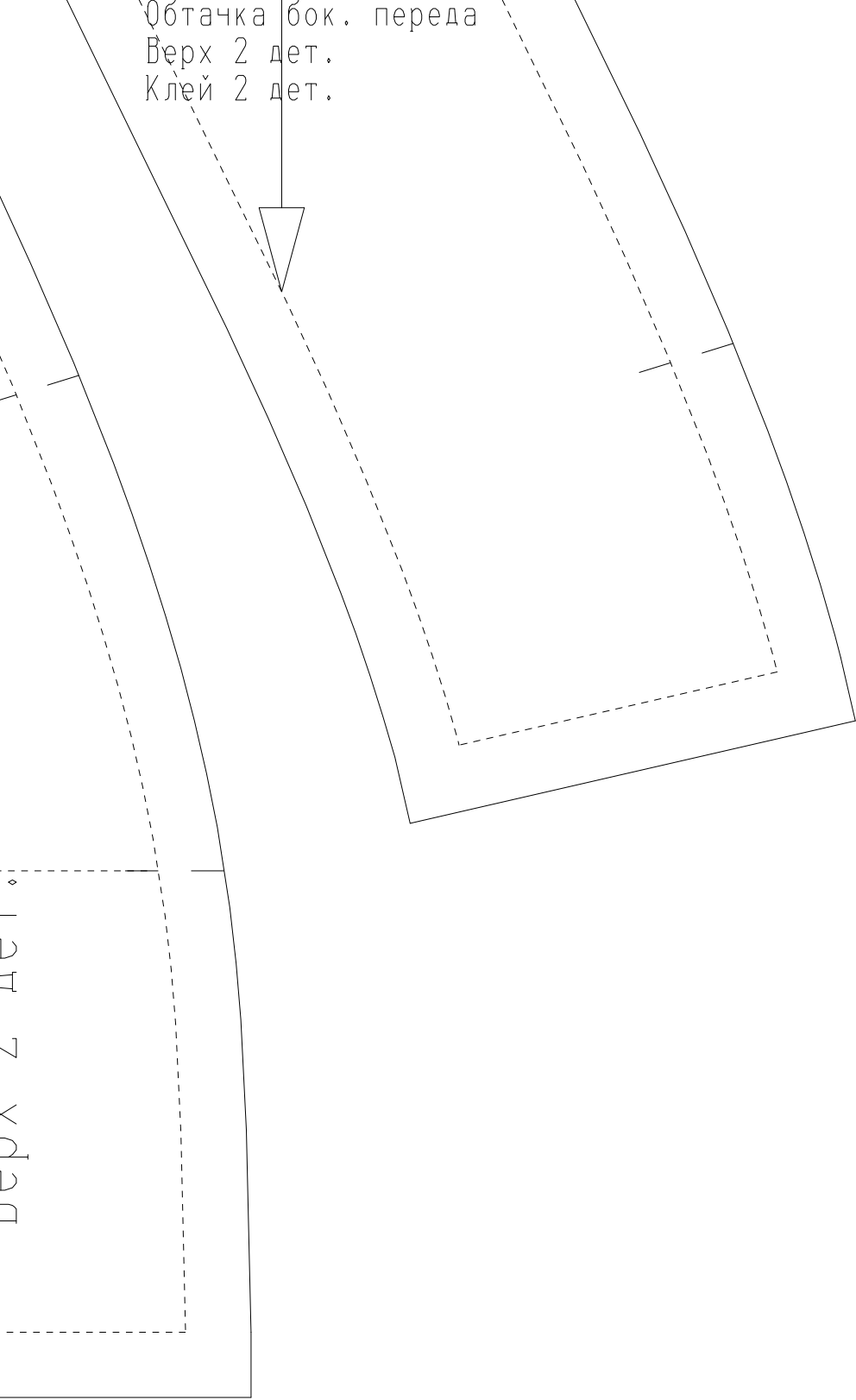

Верх 2 дет.

Платье Ж
___D42___
Спинка
Верх 1 д

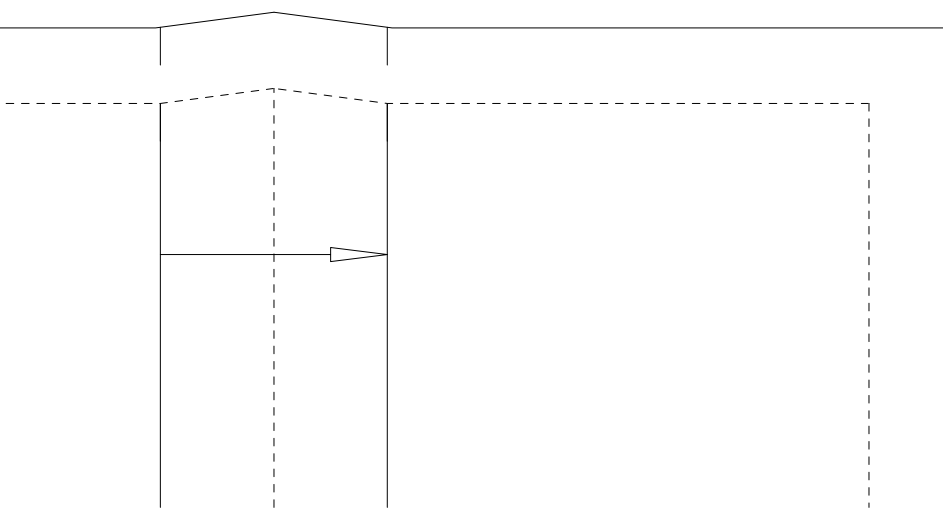

Платье Жас
___D42_0
Квадрат 10

Жасмин

дет.

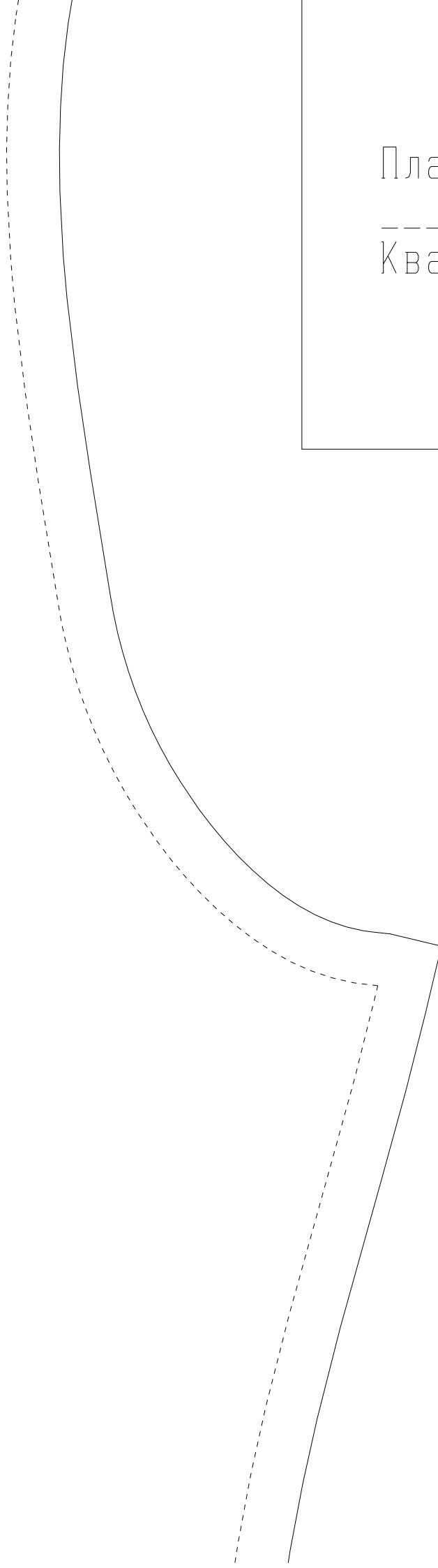
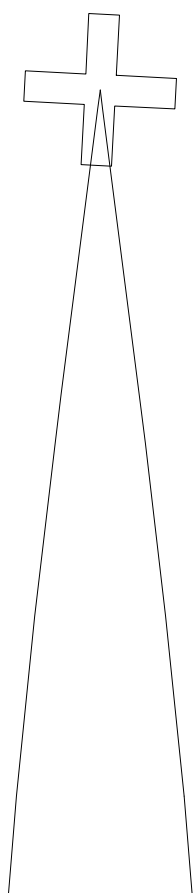

МИН

10

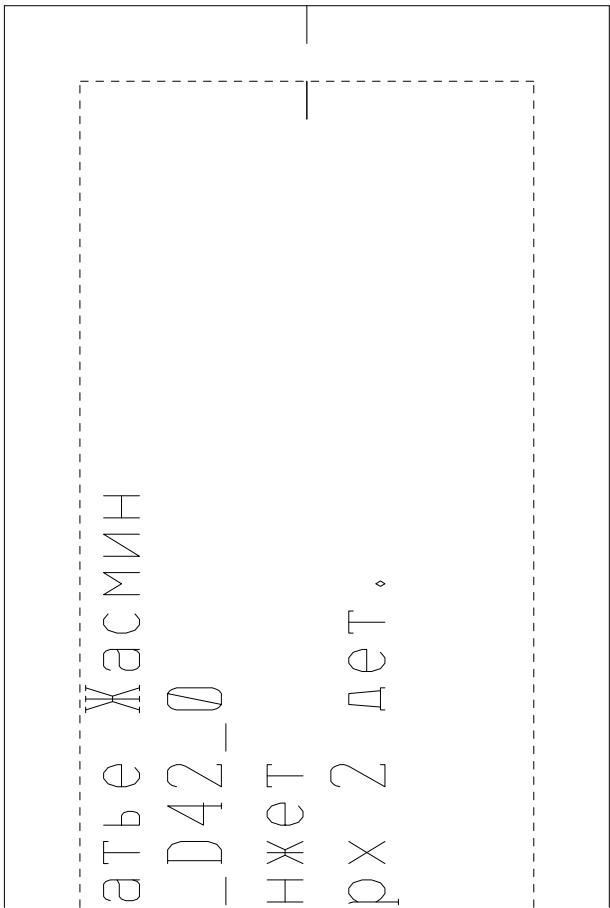

Плате Жасмин

—D42_0

НЖЕТ

рх 2 дет.

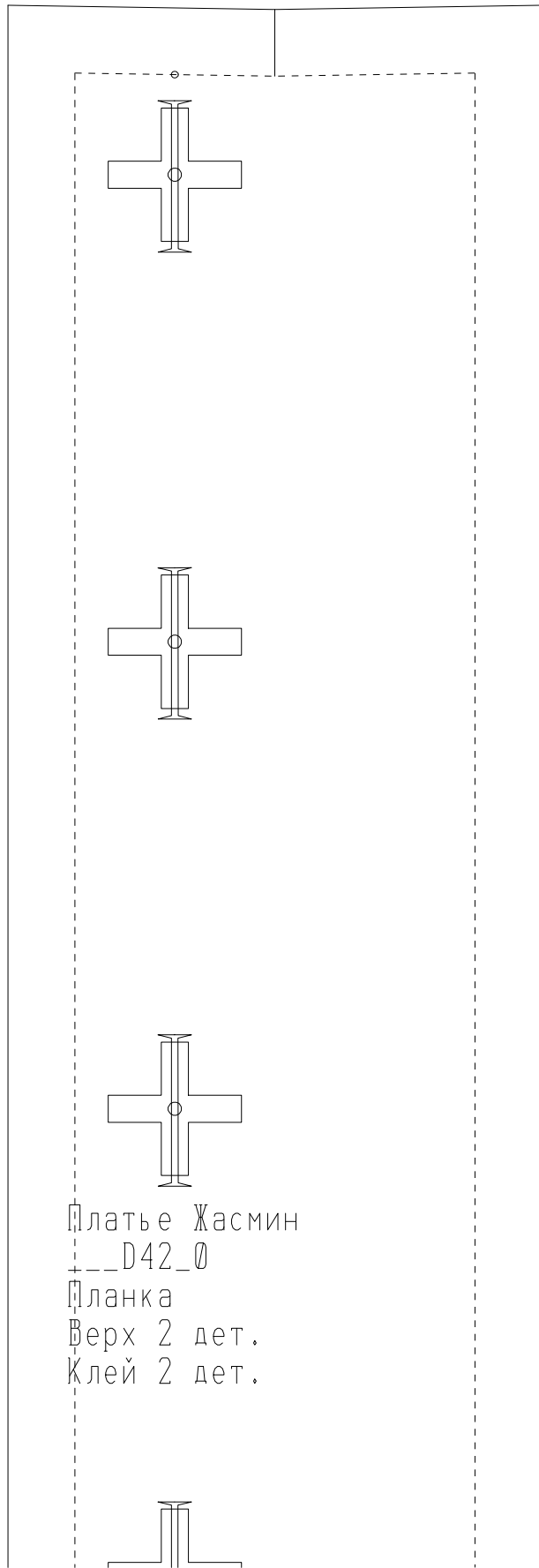

Плате Жасмин

—D42_0

Планка

Верх 2 дет.

Клей 2 дет.

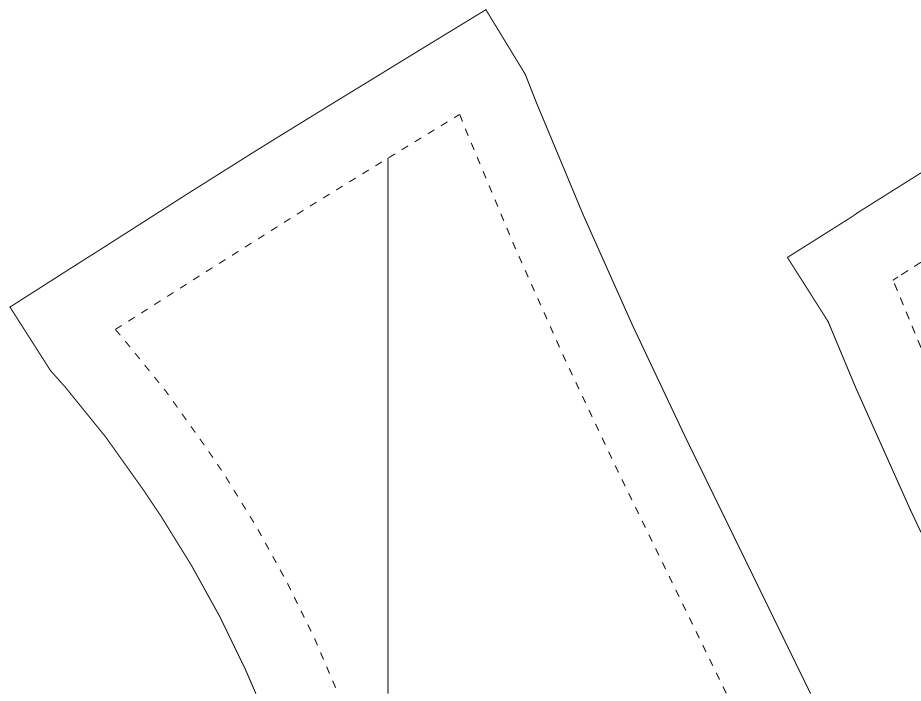
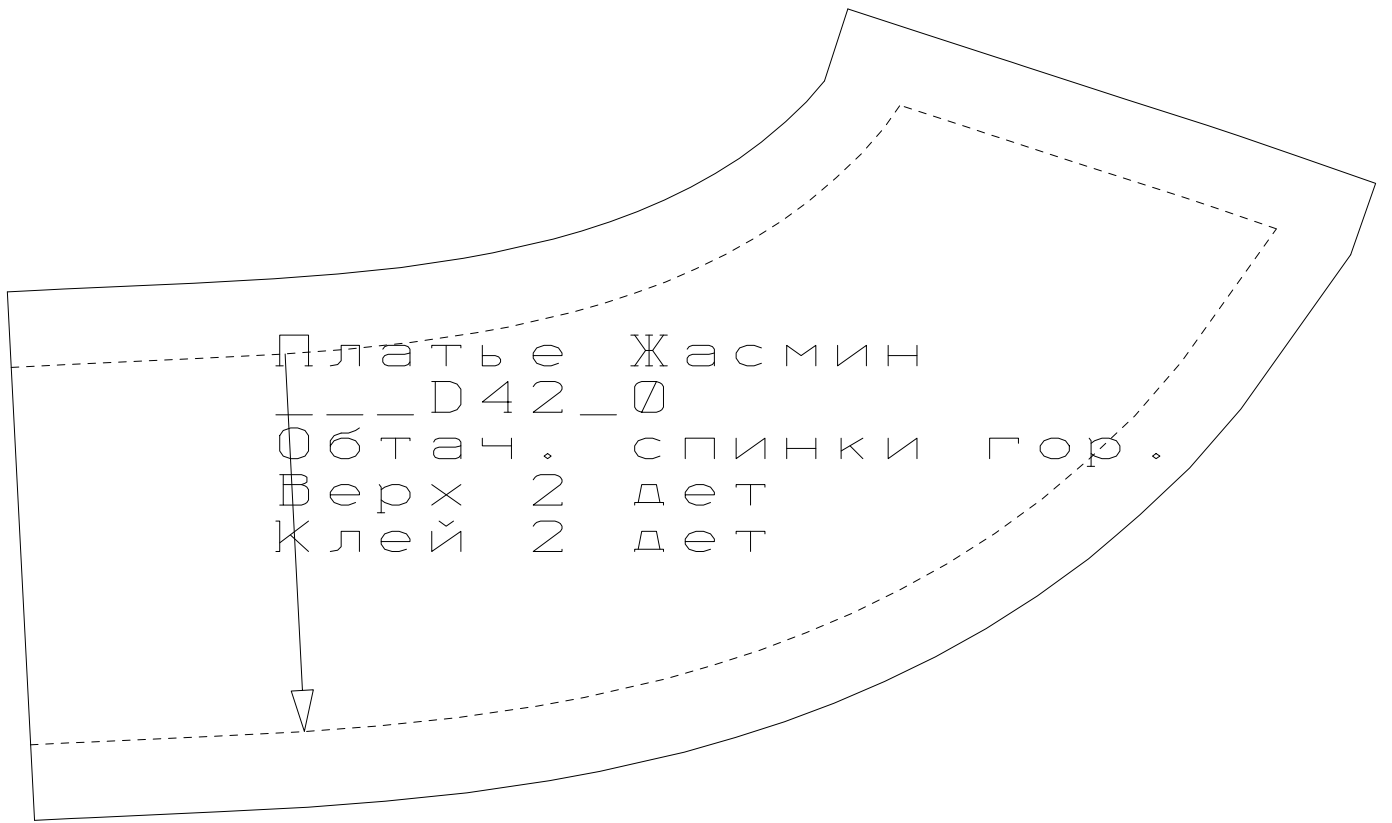



Платье Жасмин
D42_0

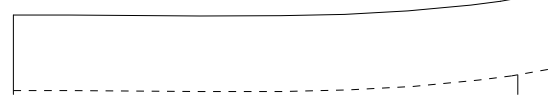

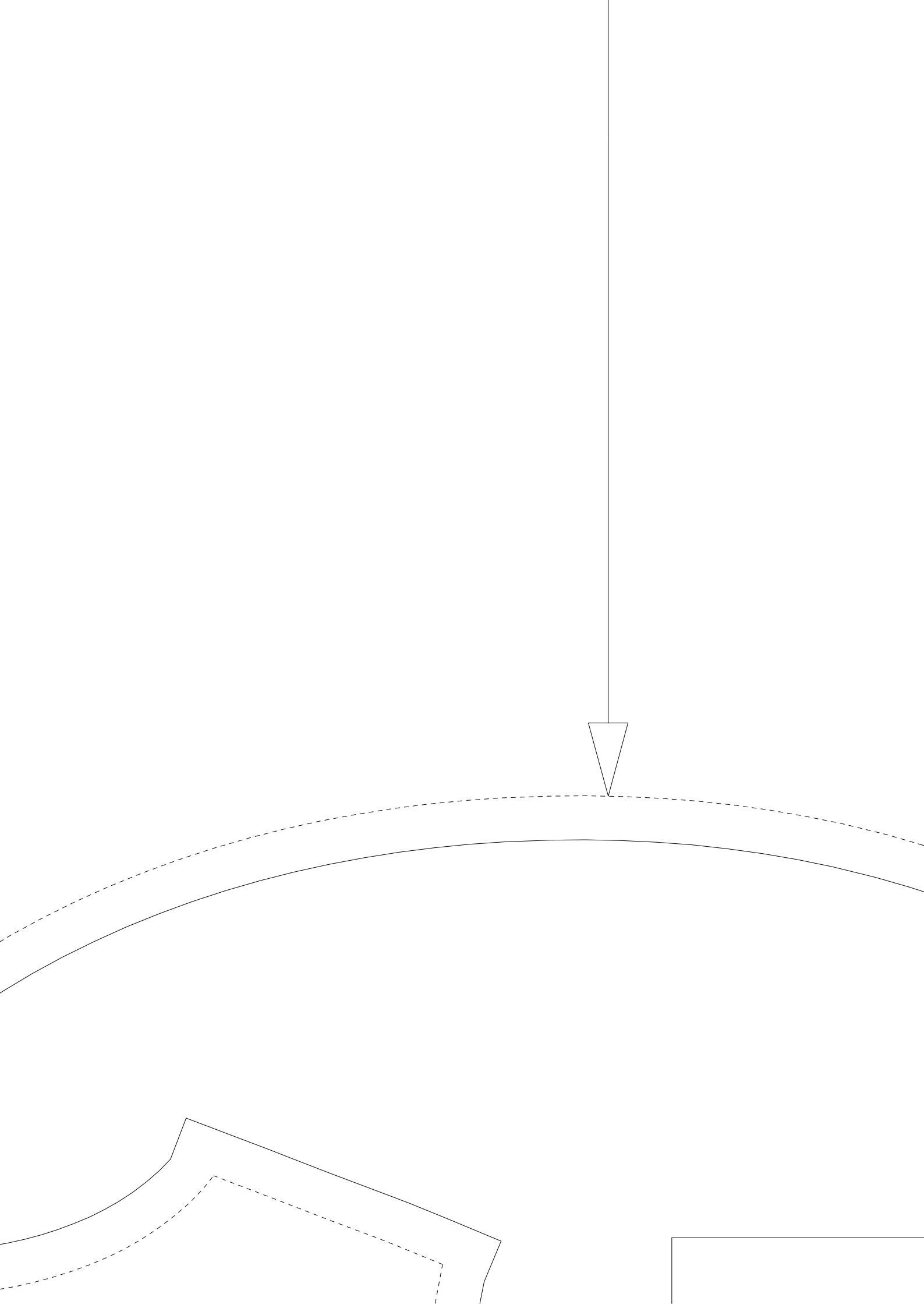



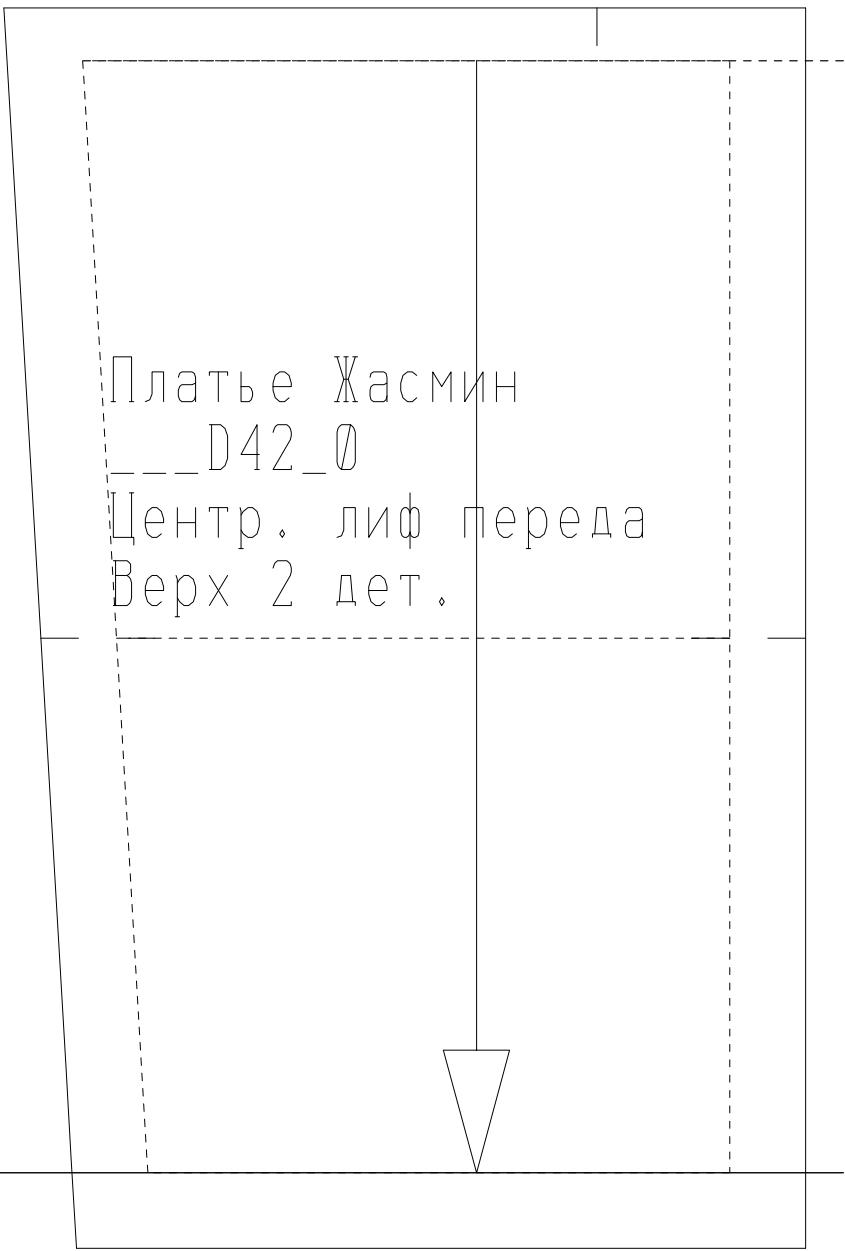



Платье Жасмин

___D42_0

Обтачка цент. пер.

Верх 2 дет.

Клей 2 дет. ▽

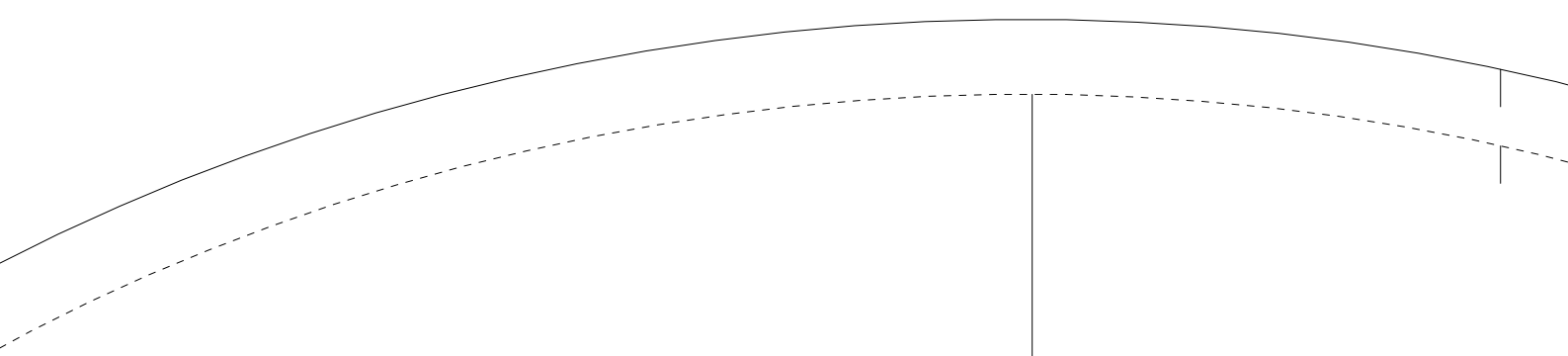

Платье Жасмин

___D42_0

Рукав

Верх

2 деталь

